



COMMONWEALTH OF PENNSYLVANIA  
DEPARTMENT OF GENERAL SERVICES  
HARRISBURG

Thank you for responding to the Commonwealth of Pennsylvania's Solicitation for Proposal (SFP) # 94773 to lease to the Commonwealth approximately 8,500 to 11,000 net usable square feet of Retail space in Collegeville, Montgomery, Pennsylvania. The space will be occupied by the Pennsylvania Liquor Control Board.

The availability of private and/or public parking should be included in proposals.

Enclosed you will find SFP #94773 which includes 5 appendices, including a sample draft lease.

This SFP contains information that will guide you in preparing a proposal submission on the enclosed forms. **To be considered, all proposals must be submitted utilizing the enclosed forms.** Proposals must be addressed to the Bureau of Real Estate, Room 503, North Office Building, Harrisburg, Pennsylvania 17125 and received by the Commonwealth of Pennsylvania by 3:00 P.M., November 6, 2015. **PROPOSALS WILL NOT BE ACCEPTED AFTER THIS TIME.**

**PLEASE NOTE THAT SFPs ARE NOT PUBLIC BID OPENINGS.**

**Your proposal must be submitted in a sealed envelope. THE ENVELOPE MUST BE MARKED WITH SFP #94773, AGENCY'S NAME, REAL ESTATE COORDINATOR'S NAME, SQUARE FOOTAGE, AND DUE DATE. THIS INFORMATION MUST ALSO BE SHOWN ON THE OUTSIDE OF ANY COURIER OR MAILING ENVELOPE.** Do not submit a proposal for another SFP in the same envelope with your proposal for this particular SFP. Please be advised that this is a proposal solicitation process. The Commonwealth of Pennsylvania reserves the right to reject any or all offers, waive any defect or negotiate for better terms.

This solicitation reflects material changes which have been made to the Commonwealth lease solicitation process. Payment of prevailing wages is now a requirement of the Commonwealth's leasing program when a proposer offers to construct a new facility or substantially rehabilitate an existing facility. Specific information on the payment of prevailing wages requirement can be found on Page 5 of this SFP. There are also new requirements concerning the Right to Know Law. Specific information on the disclosure of proposal contents can be found on Page 7 of this SFP.

You should address the availability of private and/or public parking in your proposal.

Please be sure to carefully read the whole document. If you have any questions concerning the attached information, please contact Abby Fox directly at (717) 317-5313.

**503 North Office Building, Harrisburg, PA 17125  
Telephone: 717-787-4394 FAX No: 717-783-0570**

**SOLICITATION FOR PROPOSAL (SFP)  
#94773**

Date of Issue:  
September 24, 2015

**Issuing Office:**  
Department of General Services  
Bureau of Real Estate  
Room 503 North Office Building  
Harrisburg, Pennsylvania 17125  
(717) 787-4394

## Table of Contents

	<u>Pages</u>
I. General Information for the Proposer	4-8
II. Proposal Requirements	9-10
Appendix A	Lease Standard Terms and Conditions
Appendix B	Required Documents
Appendix C	Building Specifications
Appendix D	Commonwealth Requirements
Appendix E	Geographic Boundaries

## I. GENERAL INFORMATION FOR THE PROPOSER

### PURPOSE

The purpose of this Solicitation for Proposal (SFP) is to obtain proposals to provide approximately 8,500 to 11,000 net usable square feet of retail space for use as a Wine and Spirits store. The space must be located within the following boundaries: two (2) mile radius of Routes 422 and 29, Collegeville, Montgomery County. Proposals which offer space outside of these boundaries cannot be considered for award of the lease.

Proposers should prepare and submit proposals to be considered by the Commonwealth of Pennsylvania (Commonwealth) for a ten (10) year lease (with options for two (2) five (5) year renewal terms) to be occupied by the PA Liquor Control Board.

The availability of private and/or public parking should be included in proposals.

### ISSUING OFFICE

The Department of General Services (DGS), Bureau of Real Estate, issues this SFP for the Commonwealth. The point of contact is:

Abby Fox  
Department of General Services  
Bureau of Real Estate  
Room 503 North Office Building  
Harrisburg, PA 17125  
(717) 317-5313

Only the DGS Bureau of Real Estate is authorized to negotiate the terms and conditions of a proposed lease agreement. No understanding shall be binding upon the Commonwealth until all of the following occur: (1) the parties' understanding has been reduced to a formal written lease agreement; (2) the lease agreement has received all necessary Commonwealth approvals, including, but not limited to, the approval of the Board of Commissioners of Public Grounds and Buildings; (3) the lease agreement has been signed by the Secretary of the Department of General Services, and (4) the fully executed lease agreement has been delivered by DGS to the selected proposer.

### SCOPE

This SFP contains instructions governing the proposals to be submitted and the material to be included therein; a description of the services to be provided; requirements that must be met to be eligible for consideration; and other requirements to be met by each interested party.

### RESPONSE DATE

To be considered, proposals must arrive at the issuing office, on or before the date and time specified in the cover letter. Proposals must be returned in the envelope provided with the proposal packet. **ALL LATE PROPOSALS SHALL BE REJECTED.**

## NOTICE TO PROPOSERS OF PREVAILING WAGE REQUIREMENTS

To the extent that a proposer offers to construct a new facility, to substantially rehabilitate an existing facility, or to substantially alter an existing facility in accordance with Commonwealth agency specifications/drawings, and the construction/substantial rehabilitation/substantial alterations will have a total estimated cost that exceeds \$25,000, the following prevailing wage requirements shall be included in the lease. “Substantial rehabilitation” is the conversion or adaptation of an existing facility into a safe, structurally sound building, by gutting and extensive re-construction, to make the building suitable for use by the Commonwealth agency. As a guideline, if the building foundations, building shell (outer walls, interior support walls or roof) or major building systems (HVAC, plumbing, electrical) are substantially altered or replaced, it is substantial rehabilitation. “Substantial alterations” are those alterations to an existing facility by the lessor in accordance with Commonwealth agency specifications/plans/drawings where final plans, drawings and specifications must be reviewed and approved by the Commonwealth agency. These terms do not include cosmetic improvements, routine maintenance, minor non-structural alterations and upgrades.

The lease shall require the lessor and lessor’s contractor(s) to pay no less than the wage rates as issued by the Secretary of the Pennsylvania Department of Labor and Industry for each craft or classification of all workers needed to perform the contract(s) for the construction/substantial rehabilitation/substantial alterations of the facility. The construction/substantial rehabilitation/substantial alterations required by the lease will be subject to the provisions, conditions, duties, requirements, remedies and penalties of the Pennsylvania Prevailing Wage Act, 43 P.S. § 165-1 *et seq.* The prevailing minimum wage predetermination, as issued by the Secretary of Labor and Industry, shall be attached to the lease and made a part of the lease. No workers may be employed in the construction/substantial rehabilitation/substantial alterations, except in accordance with the classifications in the prevailing minimum wage predetermination of the Secretary of Labor and Industry. If additional or different classifications are necessary, the lessor shall request the Department of General Services to petition the Secretary of Labor and Industry for rates for additional or different classifications.

The rent requested by proposers offering to construct a new facility or to substantially rehabilitate an existing facility or to make substantial alterations must take into consideration the requirement of the lessor and lessor’s contractor(s) to pay no less than the prevailing wage rates issued by the Secretary of Labor and Industry.

In order to view the current prevailing wages for each craft or classification of workers needed to perform the contract(s) for the construction/substantial rehabilitation/substantial alterations of the leased facility for the locality where the facility will be constructed/substantially rehabilitated go to [http://www.dli.state.pa.us/landi/li\\_apps/requestPW.asp](http://www.dli.state.pa.us/landi/li_apps/requestPW.asp) and request the prevailing wages. These are the applicable wage rates **provided** a lease is negotiated and fully executed within 120 days of the proposal response date. In the event the lease is not fully executed within this 120 day period, it will be necessary to request and obtain new, current prevailing minimum wage rates from the Secretary of Labor and Industry that the lessor or lessor’s contractors must pay to those employees involved in the construction/improvement/alteration of the leased facility.

**Proposals must include a statement indicating whether or not the rent is based upon the requirement to pay prevailing wages.**

If, after receipt of proposals, the DGS determines that the lessor and lessor's contractor(s) should pay the prevailing minimum wage rates when the lessor's proposal did not include consideration of this requirement, DGS may give the proposer the opportunity to revise its offered rental amounts to include allowance for payment of prevailing wages. When such a determination is made, the lease shall require, or be amended to require, the lessor and lessor's contractor(s) to pay the prevailing minimum wage rates as issued by the Secretary of the Pennsylvania Department of Labor and Industry. If this occurs, the lessor and DGS shall negotiate either an increase in the rental rate or the amount of a one-time payment to cover the increase in cost as a result of including this requirement. The lease will be subject to the provisions, conditions, duties, requirements, remedies and penalties of the Pennsylvania Prevailing Wage Act, 43 P.S. § 165-1 *et seq.*

### **SUBMISSION OF PROPOSALS**

To be considered, interested parties must submit a complete response to this SFP, using the format provided in the "Proposal Requirement" section of this document. An interested party will make no other distribution of the proposal. An official who is authorized to bind the interested party to its provisions must sign the proposal. For this SFP, the conditions of the proposal must remain valid for at least sixty (60) days from the date specified in the cover letter. **Moreover, the conditions of the selected proposal will become contractual obligations if a contract is entered into with the Commonwealth.**

A complete proposal package is necessary for evaluation of your proposal. Failure to include any of the required information or forms will delay evaluation of your proposal and may, at the Commonwealth's sole discretion, result in the rejection of your proposal.

The Commonwealth now allows alternate responses for one solicitation. In order to be considered as a complying submission, a proposal must initially adhere strictly to the solicitation specifications in all material regards. However, in addition to this component, a proposer may, at the proposer's discretion, submit one or more alternate proposals that vary from the specifications. In particular, the proposer may, by way of example, propose alternate finishes or spatial layouts that allow the proposer to submit a more competitive price proposal. The proposal must clearly label the primary proposal, and all alternates, and a clear breakdown of the price differentials should be delineated. DGS will consider and evaluate the primary and all alternate proposals at its sole discretion.

### **TYPE OF AGREEMENT**

The selected party will be expected to enter into a lease agreement in substantially the same form as the sample lease which is attached as **APPENDIX A** of this SFP. **The terms and conditions of this SFP and the selected party's proposal will be incorporated into the lease by reference.**

### **REJECTION OF PROPOSALS**

The Commonwealth reserves the right to reject any and/or all proposals received as a result of this request, or to negotiate separately with competing contractors. If, in the opinion of the

Commonwealth, contract negotiations with the selected party cannot be concluded **within 60 days following the selected party's receipt of a draft lease agreement**, the Commonwealth may at its sole discretion, immediately discontinue negotiations with the selected party and commence negotiations with any other interested party.

### **INCURRING COSTS**

The Commonwealth is not liable for any costs incurred by interested parties related to the preparation of their proposals for this SFP.

### **ECONOMY OF PREPARATION**

Proposals should be prepared simply and economically, providing a straightforward, concise description of the interested party's ability to meet the requirements of the SFP.

### **ORAL PRESENTATION**

An interested party that submits a proposal may be required to make an oral presentation of its development plan to DGS.

### **AMENDMENT TO THE SFP**

If it becomes necessary to revise any part of this SFP, an amendment will be issued to all interested parties who received the original SFP. **For any interested party who downloads the SFP from the DGS website, it will be that party's responsibility to check the website for amendments to the SFP prior to the submission of its proposal.**

### **SELECTED PARTY RESPONSIBILITIES**

The selected party will be required to assume responsibility for all services offered in the proposal whether or not the selected party actually performs them. Further, the Commonwealth will consider the selected party to be the sole point of contact with regard to contractual matters.

### **DISCLOSURE OF PROPOSAL CONTENTS**

- **Confidential Information.** The Commonwealth is not requesting, and does not require, confidential proprietary information or trade secrets to be included as part of proposers' submissions in order to evaluate proposals submitted in response to this SFP. Accordingly, except as provided herein, proposers should not label proposal submissions as confidential or proprietary or trade secret protected. Any proposer who determines that it must divulge such information as part of its proposal must submit the signed written statement described in subsection c.(2) below and must additionally provide a redacted version of its proposal, which removes only the confidential proprietary information and trade secrets, for required public disclosure purposes.
- **Commonwealth Use.** All material submitted with the proposal shall be considered the property of the Commonwealth of Pennsylvania and may be returned only at the issuing

office's option. The Commonwealth has the right to use any or all ideas not protected by intellectual property rights that are presented in any proposal regardless of whether the proposal becomes part of a lease. Notwithstanding any proposer copyright designations contained on proposals, the Commonwealth shall have the right to make copies and distribute proposals internally and to comply with public record or other disclosure requirements under the provisions of any Commonwealth or United States statute or regulation, or rule or order of any court of competent jurisdiction.

- **Public Disclosure.** Public records requests for proposals are governed by and shall be handled in the following manner:

After the award of a lease pursuant to this SFP, all proposal submissions are subject to disclosure in response to a request for public records made under the Pennsylvania Right-to-Know-Law, 65 P.S. § 67.101, et seq., commencing January 1, 2009. If a proposal submission contains confidential proprietary information or trade secrets, a signed written statement to this effect must be provided with the submission in accordance with 65 P.S. § 67.707(b) for the information to be considered exempt from disclosure under 65 P.S. § 67.708(b)(11).

### **NEWS RELEASES**

News releases pertaining to this project will be made in coordination with the issuing office, and subject to Commonwealth approval.

### **FACILITY ACCESS**

Consistent with safety and operational factors, the selected proposer will provide the Commonwealth unlimited access to the leased premises during the construction period.

### **PENNSYLVANIA STATE SALES AND USE TAX**

The proposed facility is subject to all applicable Pennsylvania Sales and Use Tax legislation. There is no special tax exemption for this project.

### **ORDER OF PRECEDENCE**

If any discrepancies in interpretation arise, the terms of the Lease Agreement are the first point of reference, the SFP and all attachments are the second, and the Proposal is the third.



## II. PROPOSAL REQUIREMENTS

### INTRODUCTION

This section contains instructions governing the proposals to be submitted and the material to be included in the proposal. The proposal shall be submitted in the format delineated below.

It is the obligation of the proposer to become fully cognizant of all factors relevant to the site including, but not limited to, existing and surrounding zoning and zoning requirements, physical characteristics and conditions of the site and improvements, asbestos and environmental hazards, adequacy of public facilities, utility services, legal restrictions, and all other information relating to legal requirements, land-use planning, or design requirements and restraints.

### REQUIRED DOCUMENTS

The following required documents **must** be completed accurately and submitted as part of your proposal (**APPENDIX B**):

#### 1. **GSRE -19 Proposal to Lease Space to the Commonwealth**

As indicated on GSRE – 19, certain required services should be included as part of your proposal. The required services are, but are not limited, to the following:

- a. All Utilities
  - b. Janitorial Services and Supplies (please check the janitorial schedule included in the Agency Specifications attached to this SFP.)
  - c. Trash Removal
  - d. Snow and Ice Removal
  - e. Sewer and Water
  - f. Lawn and Shrub Care
  - g. Acquisition of the Site
  - h. Permitting
  - i. All Professional Fees
  - j. Financing
  - k. Building Construction
  - l. Real Estate Taxes
  - m. Insurance
2. **GSRE - 6 Lessor Identity Disclosure**
  3. **GSRE - 47 Agency Agreement/Limited Agent Authority**
  4. **GSRE - 42M Contractor Responsibility Certification**
  5. **GSRE - 54 Notice - Bureau of Real Estate is Sole Agent for Commonwealth**
  6. **GSRE – 63 Acknowledgment/Usable Area Definition**
  7. **Prevailing Wage Pre-determination issued by the Department of Labor & Industry**

In addition to the required standard forms, a graphic schedule and narrative on the schedule through the design and construction phases of the project is required. This schedule will be used to complete **Paragraph 18** of the draft lease agreement (APPENDIX A), and will include how

the proposer plans to meet its proposed final completion date. The schedule for the development of the site should include but are not limited to:

- Test Fit
- Site Control
- Code and Building Permit Approvals
- Construction
- Utility Disconnect/Reconnect

### **ADDITIONAL INFORMATION**

In order to assist with the evaluation of your proposal, the following should be included with your proposal package:

- Drawings - Site Plan(s), Floor Plans, Elevations and Building Sections.
- Photographs - Please mark photographs for easy reference .
- Any documentation the proposer determines to be necessary to explain the proposal.

**APPENDIX A**

**LEASE STANDARD TERMS AND  
CONDITIONS**

**LEASE # \_\_\_\_\_**  
**Pennsylvania Liquor Control Board**  
**PLCB Constructed Facility # — Town**

THIS LEASE AGREEMENT ("LEASE") is executed this \_\_\_\_\_ day of \_\_\_\_\_, 20\_\_\_\_\_, by and between the Commonwealth of Pennsylvania ("Commonwealth"), acting through the Department of General Services, agent for the Pennsylvania Liquor Control Board (hereinafter called "LESSEE"), and \_\_\_\_\_ (hereinafter called "LESSOR").

WHEREAS, by the Act of April 9, 1929, P.L. 177, as amended, 71 P.S. Section 632(d), the Department of General Services is, with the approval of the Board or Commissioners of Public Grounds and Buildings, authorized and empowered to rent proper and adequate offices, rooms or accommodations for any department, board or commission which cannot be properly and adequately accommodated with offices, rooms and accommodations in the Capitol Buildings.

NOW THEREFORE, in consideration of the following mutual promises and intending to be legally bound hereby, LESSOR and LESSEE agree to the following terms and conditions:

1. **PREMISES.** LESSOR hereby lets unto LESSEE, for use by LESSEE, the premises, or part of the building, situated at the address \_\_\_\_\_ in the \_\_\_\_\_, Pennsylvania, and consisting of \_\_\_\_\_ net usable square feet ("the PREMISES"), together with the appurtenances thereto, including, but not limited to, the parking area as more fully set forth herein, and adequate means of ingress and egress to the PREMISES. For the purposes of this LEASE, "net usable square feet" has been computed by measuring the area to be used by LESSEE from the inside of the perimeter walls surrounding this area, excluding stairwells, elevator shafts, public restrooms not within the leased space, mechanical and building equipment rooms and any area used by the LESSOR.

Parking spaces associated with the PREMISES are to be used jointly by LESSEE's customers, and customers of other tenants of the property. Parking spaces are not intended for the sole use of the customers of any one or particular group of LESSOR's tenants. The parties mutually agree to designate a common parking area for use by LESSEE's employees, in order to minimize employee utilization of the customer common parking area.

2. **TERM.** The term of the LEASE shall be \_\_\_\_\_ year(s) and \_\_\_\_\_ month(s) in duration, with a target commencement on or about \_\_\_\_\_ and ending on \_\_\_\_\_ subject, however, to the LESSEE's right to cancel the LEASE as provided herein. At the expiration of this term, a holding over without one (1) calendar month written notice from either party of desire to terminate this LEASE shall be deemed a renewal thereof for the term of three (3) calendar months, and so on from term to term until either party shall give the other three (3) calendar months written notice of intention to terminate this LEASE. Every renewal shall be subject to the provisions of this LEASE.

3. **RENT.** LESSEE shall pay LESSOR rent for the use and occupancy of the PREMISES.

**PRIMARY TERM**

**OPTION TERMS**

**PROVIDED**, however, that **LESSEE** shall give written notice of its intention to exercise its option for the immediately succeeding additional term above mentioned at least thirty (30) days' prior to the expiration date of the original term of the lease or of each renewal thereof. If **LESSEE** fails to give such thirty (30) days' notice, a holding over shall be deemed a renewal for the term of three (3) months at the same rental as specified in the preceding option term and so on from term to term until this agreement is terminated by mutual consent of the parties hereto, or by notice in writing of intention to terminate from either party to the other three months before the expiration of any renewed term.

No rents shall be due or payable under this LEASE prior to its date of approval, or such other dates as approved, by the Board of Commissioners of Public Grounds and Buildings.

4. EFFECTIVE DATE. It is understood and agreed that the effective date of this LEASE will be determined by the execution of the Supplement to be Attached to Lease (Form PLCB-778). LESSOR and LESSEE do hereby agree that the effective date of occupancy and rent commencement shall be the earlier of the following dates:
- (a) Six (6) weeks after LESSOR has delivered possession of the PREMISES to the LESSEE, provided LESSOR has fulfilled the obligations of this LEASE to the satisfaction of LESSEE.
  - (b) The date the LESSEE opens for business to the public.

LESSOR and LESSEE mutually agree that the term shall commence on the first day of the month in which this LEASE is effective, as determined in the above manner, and that the ending date of the term and the commencement and ending dates of any renewals or extensions shall be adjusted accordingly.

5. GROSS LEASE. This is a gross LEASE, in which LESSOR agrees to pay all expenses associated with ownership of the property, including, but not necessarily limited to, those for common area maintenance ("CAM"), taxes, insurance, local impact fees, and advertising.
6. CANCELLATION. It is understood and agreed by the parties that:
- (a) If the governmental function for which these PREMISES are being leased is abolished, limited or restricted by an act of the legislature or law of Congress, or any action taken under authority conferred by such acts or laws, then LESSEE shall have the privilege of canceling this LEASE by giving two (2) calendar months written notice to LESSOR. Such abolitions, limitations or restrictions shall include, but shall not be limited to, an elimination of LESSEE's state liquor stores, in whole or in part, and/or any change in LESSEE's right and/or duty to operate state liquor stores.
  - (b) LESSEE reserves the right to cancel this LEASE with thirty (30) days written notice if the original location for the PREMISES selected by LESSEE is changed by LESSOR for any reason and the new location is not approved by LESSEE.
  - (c) LESSEE reserves the right to cancel this LEASE with thirty (30) days written notice if alterations to the PREMISES are not started within six (6) calendar month(s) following LESSOR's receipt of a fully executed LEASE or if the PREMISES are not ready for occupancy within two hundred and seventy (270) days following the start of preparation.
7. LESSOR'S RESPONSIBILITIES. The parties agree that LESSOR shall:

- (a) Make, at its expense, any alterations to the PREMISES described in the Specifications and Drawings, which are hereby incorporated and made a part of this LEASE as Exhibit J, provided by LESSEE before LESSEE takes possession, and until such alterations are completed, LESSEE shall not be liable for the payment of any rent.

LESSOR agrees and acknowledges that all change orders must be signed and authorized by the Department of General Services, Bureau of Real Estate. Further, any such change orders which exceed five thousand dollars (\$5,000.00) and all change orders when the aggregate of change orders will exceed fifty thousand dollars (\$50,000.00) must also be signed and authorized by the Commonwealth of Pennsylvania, Office of the Budget. Failure of the LESSOR to obtain the required signatures shall relieve the Commonwealth from any obligation to pay for any work described in such change order(s). LESSOR shall not receive remuneration which is in addition to the rent for any construction or alteration to the premises outside the scope of work, unless LESSEE has, by a fully executed lease amendment containing the details of said construction or alterations, as well as the specific cost, agreed to such payment.

- (b) Comply with all requirements of the Pennsylvania Department of Labor and Industry pertaining to safety and other hazards including fire, and ensure that the storeroom conforms to all applicable federal, state, and local building codes and laws. Any and all laws, rules, regulations, zoning permits, use and/or occupancy requirements, and fees including annual sign fees, of city, township, borough, county, state, and federal governmental entities shall be borne and obeyed by LESSOR. All phases of preparation and work shall be followed and carried out in strict accordance with such requirements, even though each item involved be not herein particularly specified. Obtaining all permits, (building, use, occupancy, etc.) shall be the responsibility of LESSOR. LESSOR shall furnish a Pennsylvania Department of Labor and Industry or local authority occupancy permit after work is completed.
- (c) Assume liability for all damages resulting from failure to maintain the PREMISES in a tenantable condition.
- (d) During the term of this LEASE and any renewals or extensions thereof, and at LESSOR's expense, keep and maintain the premises in a tenantable condition, and make all interior and exterior repairs, including all plumbing and drainage, water heating, HVAC (heating, ventilation, and air conditioning), wiring and electrical, door and door hardware, emergency lighting, smoke detecting and any other equipment necessary for an efficient, safe, unaffected store operation.

- (e) Procure, install, and maintain any and all fire alarm and sprinkler systems required by the governing authority or LESSOR's insurance policy. Responsibility for all repairs, parts, labor, any fees or fines associated with false alarms, unless caused by the willful or negligent acts of the LESSEE's personnel, agents, contractors, or invitees shall be borne by the LESSOR.
  - (f) Provide and maintain heating equipment sufficient to maintain a uniform temperature of 70 degrees Fahrenheit inside at 0 degrees outside. Provide and maintain air conditioning sufficient to maintain a uniform temperature of 75 degrees Fahrenheit dry-bulb with 50% relative humidity inside when outside design conditions are 95 degrees Fahrenheit dry-bulb and 78 degrees Fahrenheit wet-bulb temperatures.
  - (g) Provide temporary back-up electric heaters or fans, if the HVAC system is non-functional and repairs are not made within twenty-four (24) hours, to prevent damage to the building systems and LESSEE's products and to ensure continued store operations.
  - (h) Maintain the roof of the PREMISES in compliance with acceptable trade practices, free from leaks. LESSOR agrees to make repairs to the roof within thirty-six (36) hours.
  - (i) Replace ceiling tiles damaged or stained as a result of any roof, air conditioning, plumbing, or sprinkler leaks immediately upon completion of leak repair.
  - (j) Maintain floors to support one hundred fifty (150) pounds live load per square foot.
  - (k) Provide and maintain access to tractor trailer delivery facilities.
  - (l) Maintain, including snow and ice removal (within twelve hours of end of snow fall/storm) and illumination, the parking areas used for customer and/or LESSEE's employee parking. LESSOR is also responsible for snow and ice removal of sidewalk area in front of and around the lease facility.
  - (m) Maintain good condition of exterior painting and other storefront finish materials.
  - (n) At its sole expense and when discovered or when notified by LESSEE, contract with a professional pest control service to exterminate or remove termites or other structure-damaging insects or non-insect pests.
  - (o) Replace all door, window and transom glass where damaged or broken, except when glass is damaged or broken by LESSEE's personnel.
  - (p) When LESSEE's store is closed (e.g. on Sundays and state-recognized holidays), maintain sidewalk and curb in front of the PREMISES in good appearance free of refuse and in safe condition with respect to snow and ice.
  - (q) Provide and maintain tenant identification signage that meets LESSEE's approval.
  - (r) Prohibit the placing of signs of any kind or description on the outside of the building (except by LESSEE if the entire building is leased to LESSEE) and, if only part of the building is leased to LESSEE, prohibit the encroachment of signs on such part and the placing anywhere on the building of signs that are in any way misleading to the public as to the nature of the business operated on the PREMISES.
8. DAMAGE/DESTRUCTION. In the event of damage to the PREMISES by fire, flood, lightning, or other Act of God, or act of terrorism rendering it impossible or substantially inconvenient for LESSEE to continue to occupy or use the PREMISES for its operations, the LESSOR, after notice from the LESSEE of the condition shall have thirty (30) days to repair and/or restore the PREMISES to a tenantable condition. If LESSOR fails to repair and/or restore the PREMISES within said period of thirty (30) days, or if LESSOR fails to make reasonable progress during the thirty (30) day period, as determined by LESSEE in its sole discretion, LESSEE may, at its option: a.) terminate this LEASE by giving LESSOR fourteen (14) days written termination notice or b.) after first giving LESSOR fourteen (14) days written notice, repair and restore the PREMISES to a tenantable condition, and deduct such costs made in restoration of the PREMISES from the RENT due the LESSOR. At LESSEE'S option, payment of RENT shall abate as long as the PREMISES remains in an un-tenantable condition after notice to LESSOR and shall resume only after the condition has been substantially corrected. Such abatement shall be prorated on the portion of the PREMISES that is or remains un-tenantable.
9. EVENTS OF DEFAULT. Any one or more of the following events shall constitute an "Event of Default":
- a) Failure of LESSOR to provide the services without disruption or interruption as stipulated in this LEASE.
  - b) Failure of LESSOR to maintain the PREMISES in tenantable condition.
  - c) Failure of LESSOR to provide peaceful and uninterrupted possession of the PREMISES by LESSEE.
  - d) Failure of LESSOR to perform or observe any other lease obligations.
10. REMEDY. Upon the occurrence and during the continuance of an Event of Default, LESSEE may, after giving LESSOR fourteen (14) days written notice (during the fourteen day period, LESSOR shall have the opportunity to correct the event of default), exercise one or more of the following remedies:

- a) Perform, on behalf of and at the expense of LESSOR, any obligation of LESSOR under this LEASE which LESSOR has failed to perform and of which LESSEE shall have given LESSOR notice, the cost of which performance by LESSEE shall be payable by LESSOR to LESSEE upon demand or deducted by LESSEE from the RENT or any other amount due LESSOR by LESSEE.
- b) Terminate this LEASE and the tenancy created hereby.
- c) Abate payment of RENT as long as the "Event of Default" remains in effect. After corrective action has been completed by LESSOR, LESSEE shall pay LESSOR the withheld rent less any costs suffered by LESSEE or the tenant agency resulting from the event of default.
- d) Exercise any other legal and/or equitable rights or remedies available to LESSEE.

11. LESSEE'S RESPONSIBILITIES. The parties agree that LESSEE shall:

- (a) Make payments for \_\_\_\_\_ directly to the utility company or, if mutually agreed, LESSOR. All payments, whether to the utility company or LESSOR, will be made in accordance with the current tariff or rate schedule. All utilities must be separately metered for LESSEE's exclusive use. **Lessor to provide all account and meter information to allow uninterrupted transfer of services.**
- (b) Be responsible for costs of any monthly monitoring fees or required annual inspections of fire alarm or sprinkler systems required by the governing authority of LESSOR's insurance policy.
- (c) At its discretion and expense, hire routine preventive insect pest extermination services, except for termites or other structure-damaging insects.
- (d) At its discretion and expense, handle and dispose of any trash generated by its occupancy of the PREMISES.

12. CONSTRUCTION. It is understood that LESSEE will not be responsible for neither any construction started nor any expenditures made in connection with the PREMISES or this LEASE prior to LESSOR having in its possession a signed and fully executed LEASE from the Department of General Services.

13. REMODEL. LESSOR grants unconditional permission to LESSEE to remodel/refurbish the interior of the PREMISES or an area therein of LESSEE's discretion at any time during the term of this LEASE or any extensions thereof.

14. ASSIGNMENT. This LEASE shall be binding upon LESSOR, its heirs, administrators, successors and assigns. No assignment shall be made of this LEASE without prior written approval by LESSEE, which shall not be unreasonably withheld or delayed. Once approved by LESSEE, assignee of the LESSOR's rights hereunder shall provide LESSEE with proof of ownership satisfactory to LESSEE in order for LESSEE to direct rent payments under the LEASE to the assignee.

Upon LESSEE's receipt of notification under the LEASE that ownership of the PREMISES has been transferred, LESSEE reserves the right to withhold payment of rent until the assignee submits satisfactory proof of ownership requested by LESSEE. The LESSEE will not be responsible for any overpayment of rent to the assignor resulting from delay by the assignee in submitting proof of ownership. Any outstanding settlement between the assigning parties is solely their responsibility.

15. OFFSET PROVISION. LESSOR agrees that LESSEE may set off the amount of any state tax liability or other debt of LESSOR or its subsidiaries that is owed to the Commonwealth and not being contested on appeal against any payments due the LESSOR under this or any other contract with the Commonwealth.

16. USE OF CONTRACTORS OR SUBCONTRACTORS. LESSEE gives LESSOR express consent and permission to utilize the contractor or subcontractors of LESSOR's choice to perform any maintenance, construction and alterations that are LESSOR's responsibility under this LEASE.

17. SOVEREIGN IMMUNITY. The Commonwealth's exposure to liability (other than workers' compensation liability, which is insured with the State Workers' Insurance Fund) is governed by the dictates of Act 1978-152 commonly known as the Sovereign Immunity Tort Claims Act. Under the Act, sovereign immunity was reaffirmed but waived in nine (9) specific areas of liability. Eligible claims or suits against the Commonwealth, its officials, or employees within the waived areas may be settled up to two hundred fifty thousand dollars (\$250,000) each person, one million dollars (\$1,000,000) each occurrence. The Commonwealth has established a Tort Claims Self-Insurance Program to handle these claims or suits which is administered by the Department of General Services in close relationship with the Office of Attorney General. As to fire and extended coverage for furniture, fixtures, inventory, etc., the Commonwealth is self-insured for these perils under the State Insurance Fund which was established in 1915.

18. **HOLD HARMLESS.** LESSOR shall indemnify, save, and hold harmless LESSEE and any or all of its officers, agents, and employees from any and all claims, demands, actions, or liability (including, but not limited to, consequential damages and reasonable attorney's fees) of any nature based upon or arising out of:
- (a) Any service performed by LESSOR, its agents or employees pursuant to the requirements of this LEASE, except such services as are properly performed at the express direction of LESSEE.
  - (b) Any actual or alleged defective, dangerous, or un-tenantable condition of the PREMISES not caused by any act or omission of LESSEE.
  - (c) Violations by LESSOR, or noncompliance of the PREMISES by LESSOR with any statute, ordinance, rule or regulation of any governmental authority.
19. **LESSOR'S DUTY TO MITIGATE DAMAGES.** In the event LESSEE abandons the leased PREMISES, the LESSOR has an affirmative duty, to proceed in good faith and with due diligence, to make reasonable efforts to mitigate its damages or prevent further loss.
20. **ORAL MODIFICATION.** This LEASE may not be modified orally. Except as provided in this LEASE, all modifications must be by written amendment signed by both parties.
21. **INTERPRETATION.** This LEASE shall be construed and interpreted in accordance with the laws of the Commonwealth.
22. **NOTICES.** Any notice or demand from LESSEE to LESSOR or from LESSOR to LESSEE shall be in writing and shall be delivered by hand or by deposit in United States mail, postage prepaid, registered or certified, return receipt requested. It shall be LESSOR's responsibility to notify LESSEE of any change in LESSOR's address.

Notices to LESSOR shall be in an envelope addressed:

\_\_\_\_\_  
 \_\_\_\_\_  
 \_\_\_\_\_  
 \_\_\_\_\_

Notices to LESSEE shall be in an envelope addressed:

Bureau of Real Estate  
 503 North Office Building  
 Harrisburg, PA 17125

23. **No rents shall be due or payable under the Lease prior to the date of approval, or such other dates as approved by the Board of Commissioners of Public Grounds and Buildings. There is no obligation or signal of intent by the Lessee until such approvals are granted.**
24. **NOTE. It is mutually understood and agreed that this document is a draft lease. It is what had been known in the past as a rental option. If the terms and conditions of the agreement are approved by the PLCB, it will be changed into a Lease format and returned for further signature. Once the formal lease is signed and returned, it will be processed for further approvals. The lease is not approved until final approvals are granted. It is also understood that currently, the lease format is going through a review and that wording may be changed or modified between this draft lease and the formal lease document. It is the responsibility of the proposed lessor to review both document forms.**
25. **State the nature of any encumbrance on the property and date and place of record (Deferment of lien papers to accompany lease) Mortgage:** \_\_\_\_\_

27. **EXHIBITS.** Included in and made part of this LEASE are the following exhibits:

- |  |                                       |
|--|---------------------------------------|
| A—Right to Know  | F—Insurance                           |
| B—Contractor Responsibility Certification                    | G—Asbestos                            |
| C—Americans with Disabilities Act                            | I—Payment of Prevailing Minimum Wages |
| D—Nondiscrimination/Sexual Harassment                        | J—Specifications                      |
| E—Contractor Integrity Provisions for Commonwealth Contracts |                                       |



IN WITNESS WHEREOF, the parties hereto have duly executed these presents, the day and year first above written.

WITNESS/ATTEST:

\_\_\_\_\_

\_\_\_\_\_

LESSOR

=====

ATTEST:

**Commonwealth of Pennsylvania  
acting through the  
Department of General Services  
Agent for the Pennsylvania Liquor Control Board  
LESSEE**

\_\_\_\_\_

\_\_\_\_\_

Approved as to form and legality:

ACTING, SECRETARY OF GENERAL SERVICES

**Approved:  
Board of Commissioners of Public Grounds and Buildings**

\_\_\_\_\_

\_\_\_\_\_

OFFICE OF GENERAL COUNSEL

GOVERNOR

\_\_\_\_\_

\_\_\_\_\_

Date

Date

\_\_\_\_\_

\_\_\_\_\_

OFFICE OF ATTORNEY GENERAL

STATE TREASURER

\_\_\_\_\_

\_\_\_\_\_

Date

Date

**Exhibit "A"**  
**RIGHT TO KNOW LAW REQUIREMENTS**

- a. The Pennsylvania Right-to-Know Law, 65 P.S. §§ 67.101-3104, applies to this LEASE.
- b. If the LESSEE needs the LESSOR'S assistance in any matter arising out of the RTKL related to this LEASE, it shall notify the LESSOR using the legal contact information provided in this LEASE. The LESSOR, at any time, may designate a different contact for such purpose upon reasonable prior written notice to the LESSEE.
- c. Upon written notification from the LESSEE that it requires the LESSOR's assistance in responding to a request under the RTKL for information in the LESSOR's possession, constituting, or alleged to constitute, a public record in accordance with the RTKL ("Requested Information"), the LESSOR shall:
1. Provide the LESSEE, within ten (10) calendar days after receipt of written notification, access to, and copies of, any document or information in the LESSOR's possession arising out of this LEASE that the LESSEE reasonably believes is Requested Information and may be a public record under the RTKL; and
  2. Provide such other assistance as the LESSEE may reasonable request, in order to comply with the RTKL with respect to this LEASE.
- d. If the LESSOR considers the Requested Information to include a request for a Trade Secret or Confidential Proprietary Information, as those terms are defined by the RTKL, or other information that the LESSOR considers exempt from production under the RTKL, the LESSOR must notify the LESSEE and provide, within seven (7) calendar days of receiving the written notification, a written statement signed by a representative of the LESSOR explaining why the requested material is exempt from public disclosure under the RTKL.
- e. The LESSEE will rely upon the written statement from the LESSOR in denying a RTKL request for the Requested Information unless the LESSEE determines that the Requested Information is clearly not protected from disclosure under the RTKL. Should the LESSEE determine that the Requested Information is clearly not exempt from disclosure, the LESSOR shall provide the Requested

**Information within five (5) business days of receipt of written notification of the LESSEE'S determination.**

**f. If the LESSOR fails to provide the Requested Information within the time period required by these provisions, the LESSOR shall indemnify and hold the LESSEE harmless for any damages, penalties, costs, detriment or harm that the LESSEE may incur as a result of the LESSOR'S failure, including any statutory damages assessed against the LESSEE.**

**g. The LESSEE will reimburse the LESSOR for any costs associated with complying with these provisions only to the extent allowed under the fee schedule established by the Office of Open Records or as otherwise provided by the RTKL if the fee schedule is inapplicable.**

**h. The LESSOR may file a legal challenge to any LESSEE decision to release a record to the public with the Office of Open Records, or in the Pennsylvania Courts, however, the LESSOR shall indemnify the LESSEE for any legal expenses incurred by the LESSEE as a result of such a challenge and shall hold the LESSEE harmless for any damages, penalties, costs, detriment or harm that the LESSEE may incur as a result of the LESSOR'S failure, including any statutory damages assessed against the LESSEE, regardless of the outcome of such legal challenge. As between the parties, the LESSOR agrees to waive all rights or remedies that may be available to it as a result of the LESSEE's disclosure of Requested Information pursuant to the RTKL.**

**i. The LESSOR's duties relating to the RTKL are continuing duties that survive the expiration of this LEASE and shall continue as long as the LESSOR has Requested Information in its possession.**

**Exhibit B—Contractor Responsibility Certification**

1. LESSOR by submitting a proposal represents that:
  - (a) The LESSOR has read and understands the terms and conditions of the solicitation documents, and the proposal is made in accordance therewith.
  - (b) The LESSOR understands and acknowledges that all information provided by, and representations made by the LESSOR in the proposal are material and important and will be relied upon by the Department of General Services in awarding this LEASE. Any misstatement shall be treated as fraudulent concealment from the Department of the true facts relating to the submission of the proposal. A misrepresentation shall be punishable under Section 4904 of Title 18 P.C.S.A. Further, if it is later determined that the LESSOR knowingly rendered an erroneous certification, the Department may find the LESSOR in default, terminate the contract and may debar/suspend the LESSOR.
  - (c) The amount of the proposal has been arrived at independently and without consultation, communication or agreement with any other proposer or potential proposer.
  - (d) Neither the amount of the proposal nor the approximate amount of this proposal have been disclosed to any other firm or person that is a proposer or potential proposer, and it will not be disclosed before the opening.
  - (e) LESSOR certifies that it is not currently under suspension or debarment by the Commonwealth, any other state, or the federal government, and if the LESSOR cannot so certify, then it agrees to submit along with the proposal a written explanation of why such certification cannot be made. If LESSOR enters into subcontracts with or employs under this LEASE any subcontractors/individuals who are currently suspended or debarred by the Commonwealth or the federal government, or who become suspended or debarred by the Commonwealth or federal government during the term of this LEASE or any extensions or renewals thereof, the Commonwealth shall have the right to require the LESSOR to terminate such subcontracts or employment. The LESSOR agrees to reimburse the Commonwealth for the reasonable costs of investigation incurred by the Office of Inspector General for investigations of the LESSOR's compliance with terms of this or any other agreement between the LESSOR and the Commonwealth that result in the suspension or debarment of the LESSOR. Such costs shall include, but not be limited to, salaries of the investigators, including overtime; travel and lodging expenses; and expert witness and documentary fees. The LESSOR shall not be responsible for investigative costs for investigations that do not result in the LESSOR's suspension or debarment.
  - (f) The LESSOR has no outstanding, delinquent liabilities to the Commonwealth including but not limited to any taxes and unemployment compensation payments except as disclosed in its proposal. The LESSOR agrees that the Commonwealth may set off the amount of any state tax liability or other debt of the LESSOR or its subsidiaries that is owed to the Commonwealth and not being contested on appeal against any payments due the LESSOR under this or any other lease with the Commonwealth.
  - (g) The LESSOR may obtain the current list of suspended or debarred proposers at:

DGS Office of Chief Counsel  
603 North Office Bldg.  
Harrisburg, PA 17125  
717-783-6472 (telephone), 717-787-9138 (fax)  
[www.dgs.state.pa.us/debarment.htm](http://www.dgs.state.pa.us/debarment.htm)

2. LESSOR by submitting its proposal authorizes all Commonwealth agencies to release to the Department of General Services information related to liabilities to the Commonwealth, including but not limited to any taxes or unemployment compensation payments except as disclosed by the LESSOR in its proposal.
3. LESSOR's obligations pursuant to these provisions are ongoing from and after the effective date of this LEASE through the termination date thereof. Accordingly, the LESSOR shall have an obligation to inform the Commonwealth if, at any time during the term of this LEASE, it becomes delinquent in the payment of taxes, or other Commonwealth obligations, or if it or any of its subcontractors are suspended or debarred by the Commonwealth, the federal government, or any other state or governmental entity. Such notification shall be made within fifteen (15) days of the date of suspension or debarment. Failure of LESSOR to notify the Commonwealth of its suspension or debarment by the Commonwealth, the federal government, or any other state or governmental entity shall constitute an event of default of this LEASE with the Commonwealth. It is further understood that if the proposer has any outstanding liabilities to the Commonwealth, including but not limited to taxes or unemployment compensation, it will resolve the outstanding liabilities within ten (10) business days from notification of such liability.

I certify that the information on this form is true and correct to the best of my knowledge and that I am authorized to represent the LESSOR in connection with this proposal.

\_\_\_\_\_

Printed Name

\_\_\_\_\_

Signature

\_\_\_\_\_

Title

\_\_\_\_\_

Date

**Exhibit C—Americans with Disabilities Act**

1. Pursuant to federal regulations promulgated under the authority of The Americans With Disabilities Act, 28 C.F.R. Section 35.101 et seq., LESSOR understands and agrees that no individual with a disability shall, on the basis of the disability, be excluded from participation in this LEASE or from activities provided for under this LEASE. As a condition of accepting and executing the LEASE, LESSOR agrees to comply with the "General Prohibitions Against Discrimination," 28 C.F.R. Section 35.130, and all other regulations promulgated under Title II of The Americans With Disabilities Act which are applicable to the benefits, services, programs, and activities provided by the Commonwealth through contracts with outside contractors.
  
2. LESSOR shall be responsible for and agrees to indemnify and hold harmless the Commonwealth from all losses, damages, expenses, claims, demands, suits, and actions brought by any party against the Commonwealth as a result of LESSOR's failure to comply with the provisions of 1. above.

Initials\_\_\_\_\_

**Exhibit D--NONDISCRIMINATION/SEXUAL HARASSMENT CLAUSE**

The Contractor agrees:

1. In the hiring of any employee(s) for the manufacture of supplies, performance of work, or any other activity required under the contract or any subcontract, the Contractor, each subcontractor, or any person acting on behalf of the Contractor or subcontractor shall not discriminate in violation of the *Pennsylvania Human Relations Act* (PHRA) and applicable federal laws against any citizen of this Commonwealth who is qualified and available to perform the work to which the employment relates.
2. Neither the Contractor nor any subcontractor nor any person on their behalf shall in any manner discriminate in violation of the PHRA and applicable federal laws against or intimidate any employee involved in the manufacture of supplies, the performance of work, or any other activity required under the contract.
3. The Contractor and each subcontractor shall establish and maintain a written nondiscrimination and sexual harassment policy and shall inform their employees of the policy. The policy must contain a provision that sexual harassment will not be tolerated and employees who practice it will be disciplined. Posting this Nondiscrimination/Sexual Harassment Clause conspicuously in easily-accessible and well-lighted places customarily frequented by employees and at or near where the contract services are performed shall satisfy this requirement.
4. The Contractor and each subcontractor shall not discriminate in violation of PHRA and applicable federal laws against any subcontractor or supplier who is qualified to perform the work to which the contract relates.
5. The Contractor and each subcontractor represents that it is presently in compliance with and will maintain compliance with all applicable federal, state, and local laws and regulations relating to nondiscrimination and sexual harassment. The Contractor and each subcontractor further represents that it has filed a Standard Form 100 Employer Information Report (“EEO-1”) with the U.S. Equal Employment Opportunity Commission (“EEOC”) and shall file an annual EEO-1 report with the EEOC as required for employers subject to *Title VII of the Civil Rights Act of 1964*, as amended, that have 100 or more employees and employers that have federal government contracts or first-tier subcontracts and have 50 or more employees. The Contractor and each subcontractor shall, upon request and within the time periods requested by the Commonwealth, furnish all necessary employment documents and records, including EEO-1 reports, and permit access to their books, records, and accounts by the contracting agency and the Bureau of Small Business Opportunities (BSBO), for purpose of ascertaining compliance with provisions of this Nondiscrimination/Sexual Harassment Clause.

Initials\_\_\_\_\_

6. The Contractor shall include the provisions of this Nondiscrimination/Sexual Harassment Clause in every subcontract so that those provisions applicable to subcontractors will be binding upon each subcontractor.
7. The Contractor's and each subcontractor's obligations pursuant to these provisions are ongoing from and after the effective date of the contract through the termination date thereof. Accordingly, the Contractor and each subcontractor shall have an obligation to inform the Commonwealth if, at any time during the term of the contract, it becomes aware of any actions or occurrences that would result in violation of these provisions.
8. The Commonwealth may cancel or terminate the contract and all money due or to become due under the contract may be forfeited for a violation of the terms and conditions of this Nondiscrimination/Sexual Harassment Clause. In addition, the agency may proceed with debarment or suspension and may place the Contractor in the Contractor Responsibility File.

## Exhibit E---CONTRACTOR INTEGRITY PROVISIONS

It is essential that those who seek to contract with the Commonwealth of Pennsylvania ("Commonwealth") observe high standards of honesty and integrity. They must conduct themselves in a manner that fosters public confidence in the integrity of the Commonwealth contracting and procurement process.

**1. DEFINITIONS.** For purposes of these Contractor Integrity Provisions, the following terms shall have the meanings found in this Section:

- a. **"Affiliate"** means two or more entities where (a) a parent entity owns more than fifty percent of the voting stock of each of the entities; or (b) a common shareholder or group of shareholders owns more than fifty percent of the voting stock of each of the entities; or (c) the entities have a common proprietor or general partner.
- b. **"Consent"** means written permission signed by a duly authorized officer or employee of the Commonwealth, provided that where the material facts have been disclosed, in writing, by prequalification, bid, proposal, or contractual terms, the Commonwealth shall be deemed to have consented by virtue of the execution of this contract.
- c. **"Contractor"** means the individual or entity, that has entered into this contract with the Commonwealth.
- d. **"Contractor Related Parties"** means any affiliates of the Contractor and the Contractor's executive officers, Pennsylvania officers and directors, or owners of 5 percent or more interest in the Contractor.
- e. **"Financial Interest"** means either:
  - (1) Ownership of more than a five percent interest in any business; or
  - (2) Holding a position as an officer, director, trustee, partner, employee, or holding any position of management.
- f. **"Gratuity"** means tendering, giving, or providing anything of more than nominal monetary value including, but not limited to, cash, travel, entertainment, gifts, meals, lodging, loans, subscriptions, advances, deposits of money, services, employment, or contracts of any kind. The exceptions set forth in the [Governor's Code of Conduct, Executive Order 1980-18](#), the 4 Pa. Code §7.153(b), shall apply.
- g. **"Non-bid Basis"** means a contract awarded or executed by the Commonwealth with Contractor without seeking bids or proposals from any other potential bidder or offeror.

**2.** In furtherance of this policy, Contractor agrees to the following:

- a. Contractor shall maintain the highest standards of honesty and integrity during the performance of this contract and shall take no action in violation of state or federal laws or regulations or any other applicable laws or regulations, or other requirements applicable to Contractor or that govern contracting or procurement with the Commonwealth.



- b.** Contractor shall establish and implement a written business integrity policy, which includes, at a minimum, the requirements of these provisions as they relate to the Contractor activity with the Commonwealth and Commonwealth employees and which is made known to all Contractor employees. Posting these Contractor Integrity Provisions conspicuously in easily-accessible and well-lighted places customarily frequented by employees and at or near where the contract services are performed shall satisfy this requirement.
- c.** Contractor, its affiliates, agents, employees and anyone in privity with Contractor shall not accept, agree to give, offer, confer, or agree to confer or promise to confer, directly or indirectly, any gratuity or pecuniary benefit to any person, or to influence or attempt to influence any person in violation of any federal or state law, regulation, executive order of the Governor of Pennsylvania, statement of policy, management directive or any other published standard of the Commonwealth in connection with performance of work under this contract, except as provided in this contract.
- d.** Contractor shall not have a financial interest in any other contractor, subcontractor, or supplier providing services, labor, or material under this contract, unless the financial interest is disclosed to the Commonwealth in writing and the Commonwealth consents to Contractor's financial interest prior to Commonwealth execution of the contract. Contractor shall disclose the financial interest to the Commonwealth at the time of bid or proposal submission, or if no bids or proposals are solicited, no later than Contractor's submission of the contract signed by Contractor.
- e.** Contractor certifies to the best of its knowledge and belief that within the last five (5) years Contractor or Contractor Related Parties have not:
  - (1)** been indicted or convicted of a crime involving moral turpitude or business honesty or integrity in any jurisdiction;
  - (2)** been suspended, debarred or otherwise disqualified from entering into any contract with any governmental agency;
  - (3)** had any business license or professional license suspended or revoked;
  - (4)** had any sanction or finding of fact imposed as a result of a judicial or administrative proceeding related to fraud, extortion, bribery, bid rigging, embezzlement, misrepresentation or anti-trust; and
  - (5)** been, and is not currently, the subject of a criminal investigation by any federal, state or local prosecuting or investigative agency and/or civil anti-trust investigation by any federal, state or local prosecuting or investigative agency.

If Contractor cannot so certify to the above, then it must submit along with its bid, proposal or contract a written explanation of why such certification cannot be made and the Commonwealth will determine whether a contract may be entered into with the Contractor. The Contractor's obligation pursuant to this certification is ongoing from and after the effective date of the contract through the termination date thereof. Accordingly, the Contractor shall have an obligation to immediately notify the Commonwealth in writing if at any time during the term of the contract if becomes aware of any event which would cause the Contractor's certification or explanation to change. Contractor acknowledges that the Commonwealth may, in its sole discretion, terminate the contract for cause if it learns that any of the certifications made herein are currently false due to intervening factual circumstances or were false or should have been known to be false when entering into the contract.

- f.** Contractor shall comply with the requirements of the *Lobbying Disclosure Act (65 Pa.C.S. §13A01 et seq.)* regardless of the method of award. If this contract was awarded on a Non-bid Basis, Contractor must also comply with the requirements of the *Section 1641 of the Pennsylvania Election Code (25 P.S. §3260a)*.
- g.** When Contractor has reason to believe that any breach of ethical standards as set forth in law, the Governor's Code of Conduct, or these Contractor Integrity Provisions has occurred or may occur, including but not limited to contact by a Commonwealth officer or employee which, if acted upon, would violate such ethical standards, Contractor shall immediately notify the Commonwealth contracting officer or the Office of the State Inspector General in writing.
- h.** Contractor, by submission of its bid or proposal and/or execution of this contract and by the submission of any bills, invoices or requests for payment pursuant to the contract, certifies and represents that it has not violated any of these Contractor Integrity Provisions in connection with the submission of the bid or proposal, during any contract negotiations or during the term of the contract, to include any extensions thereof. Contractor shall immediately notify the Commonwealth in writing of any actions for occurrences that would result in a violation of these Contractor Integrity Provisions. Contractor agrees to reimburse the Commonwealth for the reasonable costs of investigation incurred by the Office of the State Inspector General for investigations of the Contractor's compliance with the terms of this or any other agreement between the Contractor and the Commonwealth that results in the suspension or debarment of the Contractor. Contractor shall not be responsible for investigative costs for investigations that do not result in the Contractor's suspension or debarment.
- i.** Contractor shall cooperate with the Office of the State Inspector General in its investigation of any alleged Commonwealth agency or employee breach of ethical standards and any alleged Contractor non-compliance with these Contractor Integrity Provisions. Contractor agrees to make identified Contractor employees available for interviews at reasonable times and places. Contractor, upon the inquiry or request of an Inspector General, shall provide, or if appropriate, make promptly available for inspection or copying, any information of any type or form deemed relevant by the Office of the State Inspector General to Contractor's integrity and compliance with these provisions. Such information may include, but shall not be limited to, Contractor's business or financial records, documents or files of any type or form that refer to or concern this contract. Contractor shall incorporate this paragraph in any agreement, contract or subcontract it enters into in the course of the performance of this contract/agreement solely for the purpose of obtaining subcontractor compliance with this provision. The incorporation of this provision in a subcontract shall not create privity of contract between the Commonwealth and any such subcontractor, and no third party beneficiaries shall be created thereby.
- j.** For violation of any of these Contractor Integrity Provisions, the Commonwealth may terminate this and any other contract with Contractor, claim liquidated damages in an amount equal to the value of anything received in breach of these Provisions, claim damages for all additional costs and expenses incurred in obtaining another contractor to complete performance under this contract, and debar and suspend Contractor from doing business with the Commonwealth. These rights and remedies are cumulative, and the use or non-use of any one shall not preclude the use of all or any other. These rights and remedies are in addition to those the Commonwealth may have under law, statute, regulation, or otherwise.

## **Exhibit F—Insurance**

1. For the term of the LEASE, LESSOR shall procure and maintain at its expense the following types of insurance, issued by companies acceptable to the LESSEE and authorized to conduct such business under the laws of the Commonwealth:
  - (a) Worker's Compensation Insurance for all of LESSOR's agents, servants and/or employees and those of any contractor engaged by LESSOR in work at the PREMISES in accordance with the Worker's Compensation Act of 1915 and any supplements or amendments thereto.
  - (b) Public liability and property damage insurance to protect LESSEE, LESSOR and any and all contractors from claims for damages for personal injury (including bodily injury), sickness or disease, accidental death and damage to the property, including loss of use resulting from property damage, which may arise from services performed by LESSOR, its agents or employees under this LEASE or from an alleged defective, dangerous or untenable condition of the PREMISES. The limits of such insurance shall be in an amount not less than five hundred thousand dollars (\$500,000) each person and two million dollars (\$2,000,000) each occurrence, personal injury and property damage combined. Such policies shall be occurrence-made rather than claims-made policies and shall name the Commonwealth as an additional insured.
  - (c) Fire and extended coverage insurance for the PREMISES and contents in an amount not less than the value of the building plus an amount to cover all equipment, furniture, and other property owned by LESSOR in the PREMISES to the full value thereof. The Commonwealth shall be named thereon as an additional insured.
2. Prior to LEASE commencement, LESSOR shall provide LESSEE with current certificates of insurance. The LESSOR's certificates shall contain a provision that the coverage afforded under the policies will not be cancelled or changed until at least thirty (30) days written notice is given to the LESSEE. LESSOR shall also require certificates of insurance of all other tenants under LESSOR's jurisdiction who are directly adjacent to LESSEE's PREMISES in accordance with the aforementioned requirements.

Initials\_\_\_\_\_

## Exhibit G—Asbestos

1. LESSOR certifies that an asbestos inventory has been completed relative to the PREMISES by an expert properly certified pursuant to state law and such inventory disclosed that there is not any exposed hazardous friable asbestos present in the PREMISES. LESSOR further covenants and agrees that if, at any time during the term of this LEASE or any renewals thereof, it is determined that exposed hazardous friable asbestos is present in the PREMISES and that employees of LESSEE are being exposed to the emission of hazardous friable asbestos fibers within the PREMISES in excess of exposure limits established by applicable law, LESSOR shall, at its sole cost and expense, and to the extent recommended by an expert and approved by LESSEE retained by LESSOR as required by law:

- (a) Encapsulate or otherwise contain the hazardous friable asbestos in the PREMISES; or
- (b) Remove and replace the hazardous friable asbestos in the PREMISES to a safe condition in accordance with all applicable laws or regulations.

LESSEE agrees to notify the LESSOR immediately if at any time LESSEE becomes aware that asbestos is present and/or that employees of LESSEE are/have been exposed to asbestos fibers.

Notwithstanding anything to the contrary in the foregoing, if the hazardous friable asbestos is introduced to the PREMISES, or made friable, or is otherwise disturbed or made hazardous by the willful or negligent conduct of LESSEE, its officers, agents, servants, contractors or employees, then LESSOR shall perform the tasks specified in (a) or (b) above at LESSEE's expense.

2. LESSOR further agrees to protect, indemnify and save LESSEE harmless from and against any and all liabilities, losses, damages, costs and expenses arising from judgments pursuant to which it is judicially determined that injuries suffered by the damaged party were proximately caused by exposure during the LEASE term to exposed hazardous friable asbestos located within the PREMISES which resulted from the LESSOR's breach of (a) or (b) above. Notwithstanding anything to the contrary in the foregoing, LESSOR's obligations to protect, indemnify and save LESSEE harmless shall not apply to judgments arising from exposure to hazardous friable asbestos when the asbestos material was either introduced to the PREMISES or made friable or otherwise disturbed or made hazardous by the willful or negligent conduct of LESSEE, its officers, agents, contractors, servants or employees.
3. In the event a Commonwealth employee brings any action at law or otherwise against the Commonwealth for injuries arising from exposure to hazardous friable asbestos in the PREMISES, the Commonwealth agrees to assert that such action is barred by the Workmen's Compensation Act (the "Act"), 71 P.S. Section 481, or any similar worker's compensation act, which provides that compensation under the Act shall be the Commonwealth's sole and exclusive liability for such injuries.

Initials\_\_\_\_\_

## Exhibit I – Prevailing Wage

PAYMENT OF PREVAILING MINIMUM WAGES. LESSOR and LESSOR'S contractor(s) must comply with the following conditions, provisions and requirements in the construction of the building, substantial rehabilitation of the building and/or substantial alterations to the PREMISES:

- a. LESSOR AND LESSOR'S contractors shall pay at least the wage rates as determined by the Secretary of the Pennsylvania Department of Labor and Industry and shall comply with the conditions of the Prevailing Wage Act of August 15, 1961, and the regulations issued thereto, to assure the full and proper payment of the rates.
- b. Workers in the construction of the building, substantial rehabilitation of the building and/or substantial alterations to the PREMISES shall be paid at least the general prevailing minimum wage rates as set forth in the prevailing minimum wage predetermination, issued by the Secretary of Labor and Industry.
- c. These requirements apply to work performed in the construction of the building, substantial rehabilitation of the building and/or substantial alterations to the PREMISES by LESSOR, LESSOR'S contractor(s) and all subcontractors.
- d. LESSOR shall insert in all its contracts for the construction of the building, substantial rehabilitation of the building and/or substantial alterations to the PREMISES and shall require the contractor(s) to insert in each of its subcontracts the stipulations contained in these provisions.
- e. No workers may be employed in the construction of the building, substantial rehabilitation of the building and/or substantial alterations to the PREMISES except in accordance with the classifications in the prevailing minimum wage predetermination of the Secretary. **NOTE: If additional or different classifications are necessary, LESSOR shall request the Department of General Services to petition the Secretary of Labor and Industry for rates for additional or different classifications.**
- f. Workers employed or working in the construction of the building, substantial rehabilitation of the building and/or substantial alterations to the PREMISES shall be paid unconditionally, regardless of whether a contractual relationship exists or the nature of a contractual relationship which may be alleged to exist between a contractor, subcontractor and worker, at least once a week, without deduction or rebate, on any account, either directly or indirectly except authorized deductions, the full amounts due at the time of payment, computed as the rates applicable to the time worked in the appropriate classification. Nothing in the lease, the Prevailing Wage Act or the regulations promulgated pursuant to the Act prohibits the payment of more than the general prevailing minimum wage rates as determined by the Secretary to a worker on a public work.
- g. LESSOR shall require its contractor(s) and each subcontractor to post for the entire period of the construction of the building, substantial rehabilitation of the building and/or substantial alterations to the PREMISES the wage determination decisions of the Secretary, including the effective date of changes thereof, in a prominent and easily accessible place or places at the site of the work and at the places used by them to pay workers their wages. The posted notice of wage rates shall contain the following information:
  - (i) The name of project.
  - (ii) The name of the Commonwealth agency that will be the tenant in the facility.
  - (iii) The crafts and classifications of the workers listed in the Secretary's general prevailing minimum wage rate determination for the particular project.
  - (iv) The general prevailing minimum wage rates determined for each craft and classification and the effective date of changes.
  - (v) A statement advising workers that if they have been paid less than the general prevailing minimum wage rate for the job classification or that the contractor or subcontractor are not complying with the act or this title, they may file a protest in writing with the Secretary of Labor and Industry within 3 months of the date of the occurrence, objecting to the payment to the contractor to the extent of the amount due or to become due to them as wages for work performed on the public work project. A worker paid less than the rate specified in the contract shall have a civil right to action for the difference between the wage paid and the wages stipulated in the contract, which right of action shall be exercised within 6 months from the occurrence of the event creating the right.

Initials\_\_\_\_

- h. LESSOR shall require its contractor(s) and each subcontractor to keep an accurate record showing the name, craft or classification, number of hours worked per day and the actual hourly rate of wage paid, including employee benefits, to each worker employed by him in connection with the public work. The record shall include deductions from each worker. The record shall be preserved for 2 years from the date of payment and shall be open at reasonable hours to the inspection of the Department of General Services, the Department of Labor and Industry and the tenant agency.
- i. Apprentices shall be limited to numbers in accordance with the bona fide apprenticeship program registered with and approved by The Pennsylvania Apprenticeship and Training Council and only apprentices whose training and employment are in full compliance with The Apprenticeship and Training Act, approved July 14, 1961, and the regulations issued thereto shall be employed on the public work project. A worker using the tools of a craft who does not qualify as an apprentice within this subsection shall be paid the rate predetermined for journeymen in that particular craft or classification.
- j. Wages shall be paid without deductions except authorized deductions. Employers not parties to a contract requiring contributions or employee benefits which the Secretary of Labor and Industry has determined to be included in the general prevailing minimum wage rate shall pay the monetary equivalent thereof directly to the workers.
- k. Payment of compensation to workers for work performed on public work on a lump sum basis, or a piece of work system, or a price certain for the completion of a certain amount of work, or the production of a certain result shall be deemed a violation of the Prevailing Wage Act and the lease, regardless of the average hourly earnings resulting therefrom.
- l. LESSOR shall require its contractor(s) and each subcontractor to file a statement each week and a final statement at the conclusion of the work on the contract under oath, and in form satisfactory to the Secretary, certifying that workers have been paid wages in strict conformity with the provisions of the contract as prescribed by this provision or if wages remain unpaid to set forth the amount of wages due and owing to each worker respectively.
- m. The provisions of the Prevailing Wage Act and the regulations issued thereto are incorporated by reference in the LEASE.
- n. As used in this paragraph, "substantial rehabilitation" is the conversion or adaptation of an existing facility into a safe, structurally sound building, by gutting and extensive re-construction, to make the building suitable for use by LESSEE.
- o. As used in this paragraph, "substantial alterations" are those alterations to an existing facility by LESSOR in accordance with the specifications, plans, or drawings contained in the LEASE or where the final plans, drawings or specifications must be reviewed and approved by LESSEE.



#### PREVAILING WAGES PROJECT RATES

Note: If additional or different classifications are necessary, Lessor shall request the Department of General Services to petition the Secretary of Labor and Industry for rates for additional or different classifications.

<http://www.portal.state.pa.us/portal/server.pt?open=514&objID=622703&mode=2>

Initials\_\_\_\_

**APPENDIX B**  
**COMMONWEALTH OF PENNSYLVANIA**  
**REQUIRED DOCUMENTS**

1. GSRE-19 Proposal to Lease Space to the Commonwealth
2. GSRE-6 Lessor Identity Disclosure (*see attached instructions*)
3. GSRE-47 Agency Agreement/Limited Agent Authority
4. GSRE-42M Contractor Responsibility Certification
5. GSRE-54 Notice – Bureau of Real Estate is Sole Agent for the Commonwealth
6. GSRE-63 Acknowledgment/Useable Area Definition

*Forms listed above are available electronically at the link below*

<http://www.portal.state.pa.us/portal/server.pt?open=512&objID=1346&&SortOrder=100&level=2&parentid=1231&css=L2&mode=2&cached=true>

7. Prevailing Wage Pre-determination from the Department of Labor and Industry (*go to [http://www.dli.state.pa.us/landi/li\\_apps/requestPW.asp](http://www.dli.state.pa.us/landi/li_apps/requestPW.asp) and request the prevailing wages. See attached instructions and Page 6 of this SFP for additional information*)

## **APPENDIX C**

### **BUILDING SPECIFICATIONS**



COST BREAKDOWN  
PLCB TENANT IMPROVEMENT WORK

ITEM	DESCRIPTION	COST	COST PER SQUARE FOOT
1	GENERAL REQUIREMENTS		
2	SELECT DEMOLITION		
3	CONCRETE		
4	MASONRY		
5	METALS		
6	ROUGH & FINISH CARPENTRY		
7	THERMAL & MOISTURE PROTECTION		
8	WOOD DOORS		
9	HOLLOW METAL DOORS & FRAMES		
10	ALUMINUM ENTRANCE SYSTEM & GLAZING		
11	FINISH HARDWARE		
12	TRAFFIC DOOR		
13	METAL STUDS & GYPSUM BOARD		
14	ACOUSTICAL CEILINGS		
15	VINYL TILE FLOORING		
16	CARPET TILE FLOORING		
17	PAINTING		
18	TOILET ACCESSORIES		
19	FIRE EXTINGUISHERS		
20	EXTERIOR SIGNAGE		
21	SPRINKLER SYSTEM		
22	PLUMBING		
23	HVAC SYSTEMS		
24	ELECTRICAL LIGHTING PACKAGE		
25	ELECTRICAL - ALL OTHER		
26	PHONE & DATA CABLING		
27	FIRE ALARM SYSTEM		
28	FINAL CLEANING		
29	(EXTRA)		
30	(EXTRA)		

STORE LOCATION \_\_\_\_\_

	TOTAL COST		
--	------------	--	--

OPENING	SIZE	MATERIAL	FRAME	HOLDING	REMARKS
①	6'-0" x 7'-6"	ALUM	ALUM	SEE SPEC	WIND GUARD
②	6'-0" x 7'-6"	ALUM	ALUM	SEE SPEC	WIND GUARD
③	12'-0" x 7'-6"	ALUM	ALUM	SEE SPEC	AUTO R-ROLLING
④	3'-4" x 2'-4"	WOOD	WOOD	GATE LATCH, SPONGE HINGE	BY FLOOR, 4" UNDERCUT
⑤	3'-4" x 2'-4"	WOOD	WOOD	GATE LATCH, SPONGE HINGE	BY FLOOR, 4" UNDERCUT
⑥	3'-0" x 5'-0"	WOOD	WOOD	DOOR HANDLE W/ LOCKSET, SPONGE HINGE	BY FLOOR, 4" UNDERCUT
⑦	3'-0" x 7'-0"	WOOD	STEEL	STAINLESS STEEL HAND PUSH PLATE, 3/4" x 4" STAINLESS STEEL PLATE (BOTH SIDES)	IMPACT DOOR W/ 9" x 24" REINFORCING
⑧	3'-0" x 6'-6"	WOOD	HM	PRIMARY LOCKSET, CLOSER, BUTTS W/ STOPS, SLIPSPICES	
⑨	3'-0" x 6'-6"	WOOD	HM	PRIMARY LOCKSET, CLOSER, BUTTS W/ STOPS, SLIPSPICES	
⑩	3'-0" x 6'-6"	WOOD	HM	EXISTING	EXISTING DOOR
⑪	3'-0" x 6'-6"	WOOD	HM	EXISTING	EXISTING DOOR
⑫	3'-0" x 7'-0"	STEEL	STEEL	DET. REMO. CLOSER, BUTTS, HINGES, FEEL HOLE, SECURITY ALARM	DELIVERY DOORS

DOOR SCHEDULE

NOTES:  
 - ALL SHELVING & CART / CUSTOM UNITS DISPLAYS PROVIDED BY PLOB  
 - TABLE AREA / OFFICE PROVIDED BY PLOB  
 - THIS PLAN REPRESENTS THE LAYOUT ESTABLISHED BY THE MINIMUM REQUIREMENTS / SPECIFICATIONS LISTED IN A PLOB EXHIBIT J SPEC.  
 - PLUMBING AND DIVIDER WALLS TO BE 7-1/2" FINISHED, STANDARD WALLS TO BE 4-7/8" FINISHED.  
 - ALL COLUMNS IN RETAIL SPACE WRAP W/ STAINLESS STEEL UP 48" A.F.F.

WALL UNITS	WINE GONDOLA UNITS	LIQUOR GONDOLA UNITS
STANDARD - TOTAL OF 36 (6 SHELVES)	STOCK SIZE 'V', TOTAL OF 2 (3 SHELVES)	STOCK SIZE 'V', TOTAL OF 2 (3 SHELVES)
SPECIALTY W/ GRAPHIC - TOTAL OF 3 (3 SHELVES)	STOCK SIZE 'C', TOTAL OF 6 (3 SHELVES)	STOCK SIZE 'C', TOTAL OF 4 (3 SHELVES)
SPECIALTY WINE FEATURE - TOTAL OF 1 (3 SHELVES)	9" WINE DISPLAY TABLE - TOTAL OF 1	9" LIQUOR DISPLAY TABLE - TOTAL OF 1
STOCKROOM DOORWAY WALL UNIT - TOTAL OF 1	WINE DISPLAY CART - TOTAL OF 3	LIQUOR DISPLAY CART - TOTAL OF 2
GRAPHIC WALL UNIT - 12 LF		
WALL UNIT - 20 LF		
PERIMETER WALL UNIT - 12 LF		

AREA SPLIT = 6228R, 3393WH  
 RETAIL SALES SPACE = 6189 SQ.FT.  
 WHOLESALE SPACE = 4277 SQ.FT.  
 TOTAL AREA = 11086 SQ.FT.  
 TOTAL SHELVING LINEAR FOOTAGE = 2086

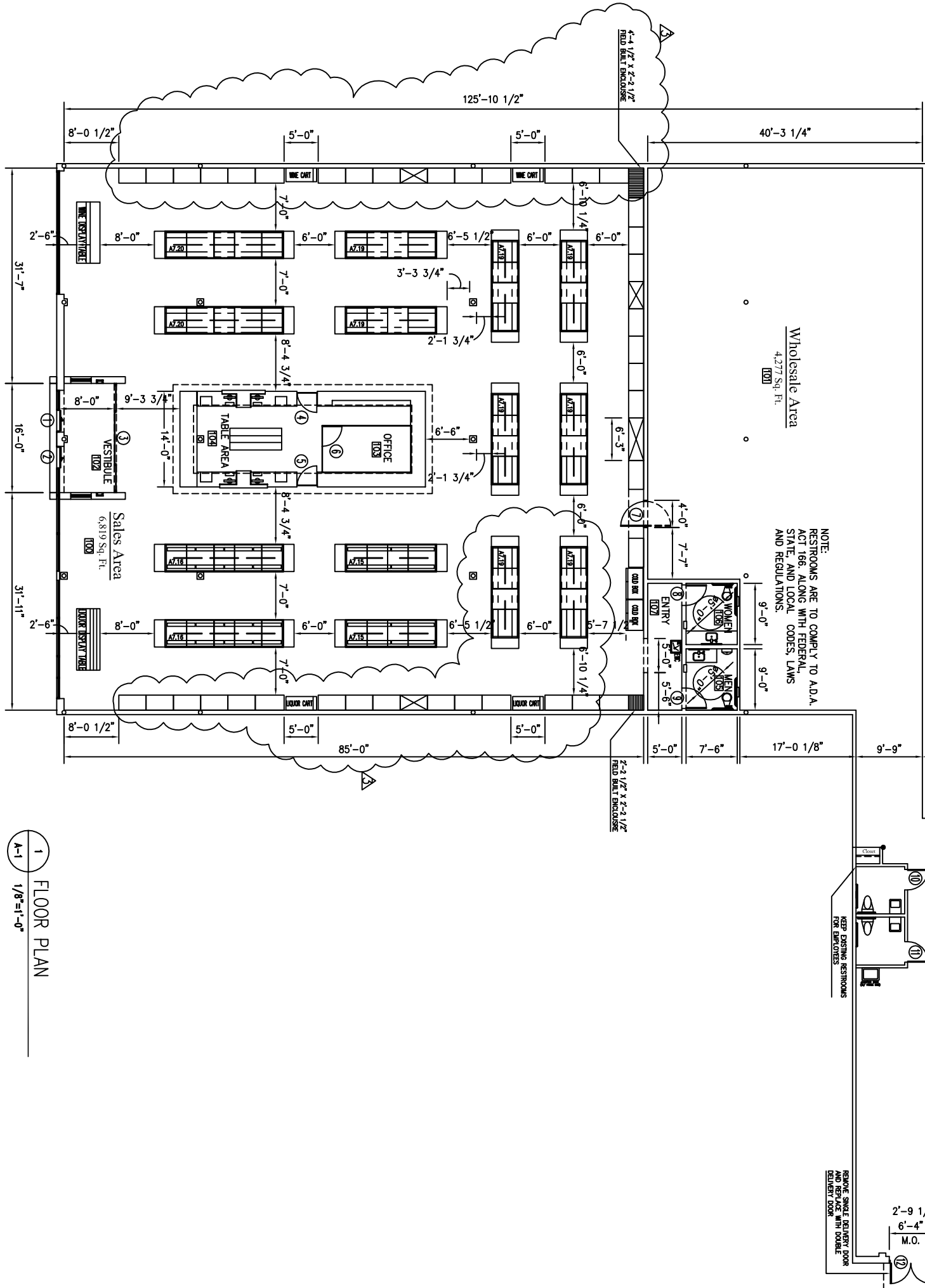
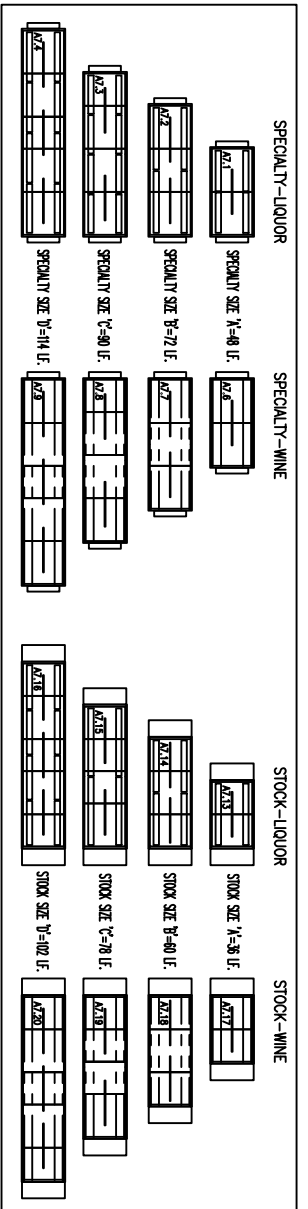

NOTE:  
 RESTROOMS ARE TO COMPLY TO A.D.A. ACT 166, ALONG WITH FEDERAL, STATE, AND LOCAL CODES, LAWS AND REGULATIONS.

NOTE:  
 1. THIS DRAWING ILLUSTRATES THE GENERAL DESIGN CONCEPT. CONSTRUCTION DOCUMENTS MUST BE PREPARED BY A DESIGN PROFESSIONAL LICENSED IN PENNSYLVANIA.  
 2. ALL DIMENSIONS AND EXISTING CONDITIONS MUST BE VERIFIED AT THE PROJECT SITE PRIOR TO THE PREPARATION OF CONSTRUCTION DOCUMENTS AND PRIOR TO CONSTRUCTION.  
 3. COMPLIANCE WITH STATE AND LOCAL BUILDING CODES, ZONING REGULATIONS AND THE REQUIREMENTS OF THE AUTHORITIES HAVING JURISDICTION IS THE RESPONSIBILITY OF THE DESIGN PROFESSIONAL WHO WILL PREPARE THE CONSTRUCTION DOCUMENTS.

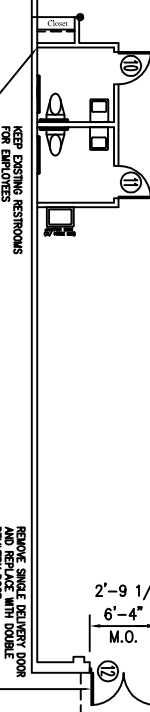

1 FLOOR PLAN  
 A-1 1/8"=1'-0"

NOTE:  
 1. G.C. TO COORDINATE RAFT WITH E.C. FOR SIZES & CLEARANCES OF LIGHT FIXTURES.  
 2. ALL SUPPORTS & OTHER MATERIALS TO BE HIDDEN WITHIN RAFT.

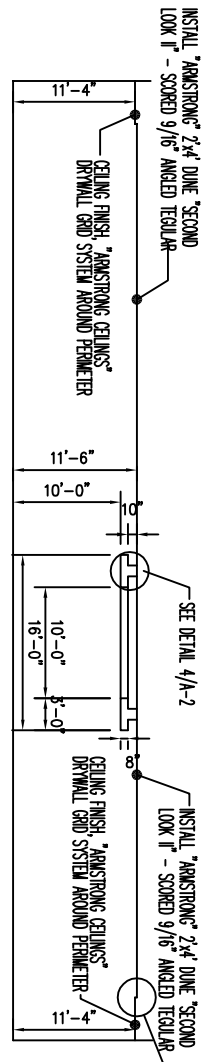

REFER TO MANUFACTURER SPECIFIC RAFT AREA  
 --LED LIGHTING INNER RAFT--

2 RAFT ELEVATION  
 A-2 NTS

SYMBOL	GENERAL DESCRIPTION
72A	RECESSED DOWN LIGHTS 16 WATTS PER UNIT (CONTECH RAN15038-X1-P)
72A	RECESSED DOWN LIGHTS 32 WATTS PER UNIT (CONTECH RAN15038-X2-P)
72B	SMOKE DETECTOR (SMOKE DETECTOR SYSTEM MUST COMPLY WITH ALL LOCAL, STATE AND FEDERAL CODES AND REGULATIONS. INSTALL ONE AT EACH CHECKOUT)
72C	TRACK LIGHTING IN GNB SOFFIT, 12 WATTS PER UNIT, WHITE. HALO BY COOPER LIGHTING. LA-1-05-30.
72D	LIGHTING IN INNER RAFT AREA 28 WATTS PER UNIT (COULI CM4-128-EPJ) OR (COULI CM2-114-EPJ)
72E	HANGING CEILING BASE LIGHT OVER DISPLAY TABLES/CONDOLAS 28 WATTS PER UNIT (PROG P8825-01 & P5199-09) CENTER OVER DISPLAYS.
72F	DOWN LIGHTS IN GNB SOFFIT 20 WATTS PER UNIT (PRSC D4LED4-409LED435K8MD25C6WT-824)
72G	DOWN LIGHTS IN GNB SOFFIT 20 WATTS PER UNIT (PRSC D4LED4-409LED435K8MD25C6WT-824)
72H	2'X2' INDIRECT RECESSED LED LIGHT (PREC LP24-3ZSKA35)
72I	NIGHT LIGHT AND EMERGENCY LIGHT UNIT SAME AS ABOVE WITH BOONIE EMERGENCY BATTERY PACK. INSTALL AS RECOMMENDED.
72J	2'X2' GENERAL PURPOSE 18 TROFFER RECESSED LAY-IN FIXTURE (LITHONIA 287B-3-431-A12-ANGL-GE870RS)
72K	(PROGRESS WALL SCONCE P7047-09 (RESTROOMS), P7047-20 (ON PREMIUM WALL UNIT))
72L	EXHAUST FAN WIRED TO SINGLE WALL SWITCH.
MULTIPLE	MULTIPLE LIGHT SWITCH LOCATION TO CONTROL OVERHEAD LIGHTING. (MOUNT 4'-6" HIGH UNLESS NOTED ON DRAWING THESE SWITCH ARE TO BE DETERMINED BY PLOC)
MULTIPLE	(MOUNT 4'-6" HIGH UNLESS NOTED ON DRAWING THESE SWITCH ARE TO BE DETERMINED BY PLOC)
72M	RECEPTACLE LOCATED IN FULL COMPLIANCE WITH A.D.A. ACT 168 AS WELL AS ALL OTHER FEDERAL, STATE AND LOCAL LAWS AND CODES.
72N	SPEAKER
72O	48" LONG 2 TUBE FLUORESCENT 18 GENERAL PURPOSE LIGHT STRIPS, FIXTURES TO BE THE Q232AM, 30 FT-C MAINTAINED. SAME AS ABOVE, WITH BOONIE EMERGENCY BATTERY PACK. INSTALL AS RECOMMENDED.
72P	NIGHT LIGHT AND EMERGENCY LIGHT UNIT, SAME AS ABOVE WITH BOONIE EMERGENCY BATTERY PACK. INSTALL AS RECOMMENDED.
72Q	EMERGENCY EXIT SIGN (LIGHTED).
72R	DELIVERY DOOR/DOCK LIGHT

- NOTES:  
 1. E.C. TO PROVIDE POWER TO L.E.D. PICK LIGHTS (F.B.O.) IN CATEGORY SIGN BOXES ON TOP OF WALL UNITS.  
 2. LAMPS FOR F2A, F3A TO BE 18PAR38/END/FL29/3000 ENDURA LED INDOOR FLOOD BY PHILIPS.  
 3. LAMPS FOR F7 AND F7A TO BE INTEGRAL 3000K LED'S.  
 4. E.C. TO PROVIDE TWO WALL SCONCES IN EACH RESTROOM AND TWO ON THE PREMIUM WINE WALL DISPLAY UNIT.  
 5. LAMPS FOR F7A TO BE 12PAR30 ENDURALED INDOOR FLOOD BY PHILIPS.

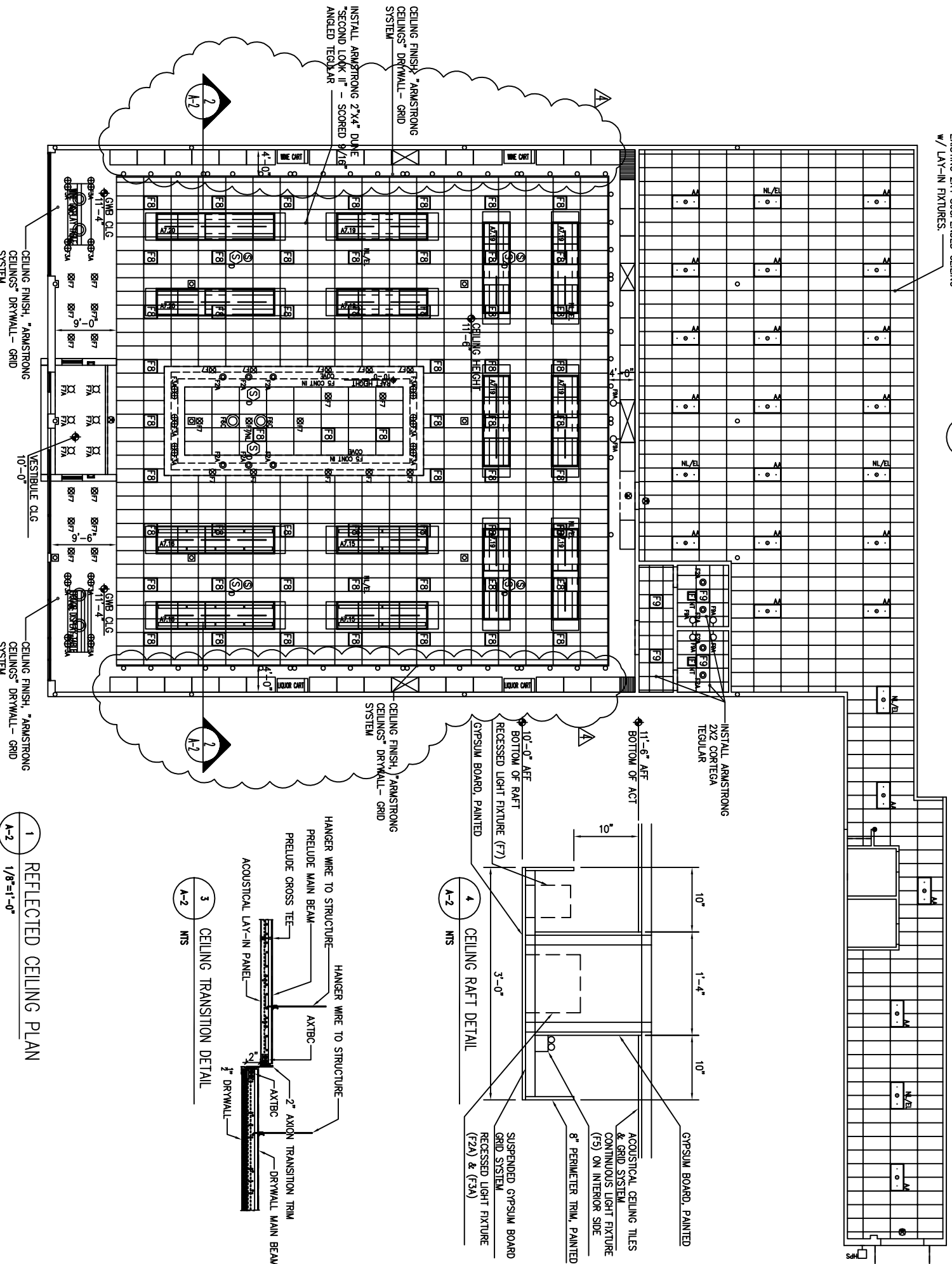

1 REFLECTED CEILING PLAN  
 A-2 1/8"=1'-0"

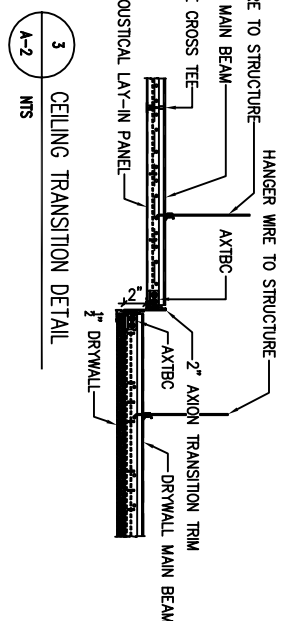

3 CEILING TRANSITION DETAIL  
 A-2 NTS

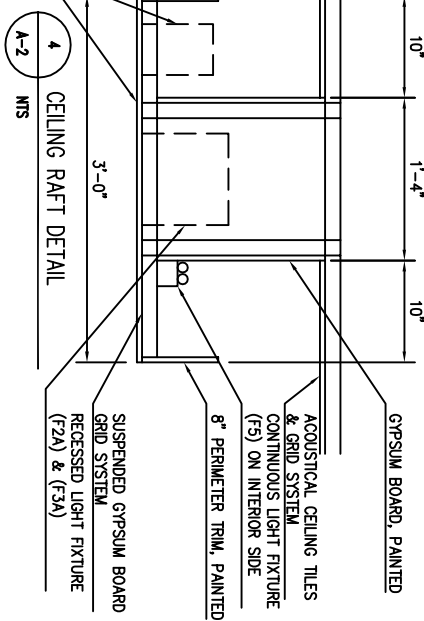

4 CEILING RAFT DETAIL  
 A-2 NTS

REVISIONS	
10/16/2011	REVISED CEILING HEIGHT, UPDATED LIGHT PACKAGE TO INCLUDE LED LIGHTS
11/19/2013	REVISED CEILING PLAN
12/26/2014	REVISED NOTES AND ADDED (S) LIGHT FIXTURES
03/17/2014	REVISED TRACK LIGHT FIXTURES

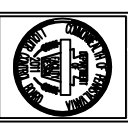

REGION: 1  
 STORE LOCATION:  
 STORE DRAWING:

REFLECTED CEILING PLAN  
 SCALE: 1/8"=1'-0"

PLCB STORE OPERATIONS  
 FACILITY DESIGN DIVISION  
 ROOM 315, NORTHWEST OFFICE BLDG.  
 HARRISBURG, PA  
 PH: 717-214-7149 / 717-783-7590

- NOTE:
- THIS DRAWING ILLUSTRATES THE GENERAL DESIGN CONCEPT. CONSTRUCTION DOCUMENTS MUST BE PREPARED BY A DESIGN PROFESSIONAL LICENSED IN PENNSYLVANIA.
  - ALL DIMENSIONS AND EXISTING CONDITIONS MUST BE VERIFIED AT THE PROJECT SITE PRIOR TO THE PREPARATION OF CONSTRUCTION DOCUMENTS AND PRIOR TO CONSTRUCTION.
  - COMPLIANCE WITH STATE AND LOCAL BUILDING CODES, ZONING REGULATIONS AND THE REQUIREMENTS OF THE AUTHORITIES HAVING JURISDICTION IS THE RESPONSIBILITY OF THE DESIGN PROFESSIONAL WHO WILL PREPARE THE CONSTRUCTION DOCUMENTS.

ELECTRICAL KEY

SYMBOL	GENERAL DESCRIPTION
	LIGHT AND FAN SWITCHES WITH A DUPLEX GROUND FAULT INTERRUPTED RECEPTACLE LOCATED IN FULL COMPLIANCE WITH A.D.A. ACT 188 AS WELL AS ALL OTHER FEDERAL, STATE AND LOCAL LAWS AND CODES
	2"x4" GANG BOX WITH DUPLEX OUTLET, CONTAINING (1) 110V 12/2 W/G LINE, ON A SEPARATE CIRCUIT (20 AMP BREAKER). THIS LINE IS FOR THE COOL BOX UNIT AND SET AT 1'-6" A.F.F.
	2x4 GANG BOX WITH DUPLEX OUTLET, CONTAINING (1) 110V LINE WITH ADDITIONAL INDEPENDENT GROUND, ON A SEPARATE CIRCUIT (12/2 W/G WIRE).
	DUPLEX GROUND FAULT INTERRUPT RECEPTACLE LOCATION (1'-6" A.F.F. UNLESS NOTED ON DRAWING).
	DUPLEX RECEPTACLE LOCATION (1'-6" A.F.F. UNLESS NOTED ON DRAWING).
	LOCATION OF LIGHTSTAT MODEL "THE-AVU" THERMOSTAT BY LIGHTSTAT INC. (MOUNT 4'-6" HIGH A.F.F. AND NOT IN AN AREA NEAR A NIGHT LIGHT)
	RECEIVER FOR THE WIRELESS DOOR SENSOR SYSTEM (OPTEX), RECEIVER (RC-20U) REQUIRES AN OUTLET SET APPROXIMATELY 8'-0" ABOVE THE FINISHED FLOOR.
	WIRELESS DOOR SENSOR SYSTEM (OPTEX) FOR ALL FRONT ENTRANCE AND EXIT DOORS. ONE TRANSMITTER (TP-20U) IS REQUIRED FOR EACH DOOR. TRANSMITTERS SHALL BE LOCATED ABOVE DOORS AND BATTERY OPERATED.
	BELL OPERATED BY PUSH BUTTON (LOCATION AT REAR DELIVERY DOOR), "EDWARD" #740, WITH #390 TRANSFORMER. MOUNT BELL APPROXIMATELY 8'-0" ABOVE THE FINISHED FLOOR.
	PUSH BUTTON, LOCATION AT REAR DELIVERY DOOR (EXTERIOR), WEATHERPROOF "EDWARD" #903.
	MULTIPLE LIGHT SWITCH LOCATION TO CONTROL OVERHEAD LIGHTING. (MOUNT 4'-6" HIGH UNLESS NOTED ON DRAWING) THESE SWITCH ARE LOCATED IN THE RETAIL SALES AREA. LEVEL OF LIGHTING CONTROL TO BE DETERMINED BY PLOC.
	MULTIPLE LIGHT SWITCH LOCATION TO CONTROL OVERHEAD LIGHTING. (MOUNT 4'-6" HIGH UNLESS NOTED ON DRAWING) THESE SWITCH ARE LOCATED IN THE WHOLESALE SALES AREA. LEVEL OF LIGHTING CONTROL TO BE DETERMINED BY PLOC.
	200 AMP MINIMUM SERVICE PANEL BOX, UNLESS NOTED ON DRAWING AS SOMETHING ELSE. SERVICE SIZE AND DISTRIBUTION DESIGNED BY LESSOR ELECTRICAL ENGINEER.
	FURNISH AND INSTALL ONE (1) WALL MOUNTED AM/FM/CD PLAYER STEREO SYSTEM WITH SPEAKERS. LOCATION OF UNIT AND SPEAKERS TO BE DESIGNATED ON THE PENNSYLVANIA LIQUOR CONTROL BOARD ELECTRICAL AND LIGHTING DRAWINGS. LOCATE UNIT 4'-6" ABOVE FINISHED FLOOR IN WHOLESALE AREA.
	4"x4" JUNCTION BOX CONTAINING (2) 110V 12/2 WITH GROUND LINES. ONE LINE IS TO BE ON A SEPARATE CIRCUIT WITH INDEPENDENT GROUND AND MUST BE LABELED. THIS LINE IS FOR THE CASH REGISTER.
	A TWO STRAND LOW VOLTAGE BUZZER WIRE FROM THE 15-1AB BUZZER LOCATED IN THE WHOLESALE AREA TO A LOCATION ABOVE THE CENTER TABLE. LEAVE A 30' PIGTAIL AT OFFICE LOCATION.
	EDWARDS MINIATURE BUZZER UNIT 15-1AB (AC/DC) WITH AN EDWARDS 590 SERIES CLASS 2 SIGNALING TRANSFORMER. MOUNTED APPROXIMATELY 8'-0" ABOVE THE FINISHED FLOOR ALONG WITH A 120V DUPLEX RECEPTACLE.
	AIR CURTAIN, "STAR" BY BERNER INT'L CORP

PHONE LINE/DATA KEY

SYMBOL	GENERAL DESCRIPTION
	PHONE OUTLET LOCATION (4'-6" A.F.F.). THIS IS AN EXTENSION FROM GENERAL STORE PHONE LINE.
	2"x4" GANG BOX WITH (2) TWO "CAT-5E" LINES ATTACHED TO A COVER PLATE WITH (2) TWO DATA LINE HOOK UP POSITIONS. USE N2, N3, N4, AND N5 TO LABEL LINES. TOP OF BOX AT 18" A.F.F. LINES RUN FROM THE POINT OF USE TO THE ROUTER.
	2"x4" GANG BOX WITH (2) TWO "CAT-5E" LINES ATTACHED TO A COVER PLATE WITH (2) TWO PHONE LINE HOOK UP POSITIONS. USE P, CC, FL, AND CL TO LABEL LINES. TOP OF BOX AT 18" A.F.F. LINES RUN FROM THE POINT OF USE TO THE PHONE BLOCK.
	SHOWS LOCATION OF THE "CAT-5E" DATA LINES AT THE ROUTER AREA. MOBILE CABINET.
	2"x4" GANG BOX WITH THREE (3) SEPARATE CAT-5E CABLES TO REGISTER #1 (REGISTER: PIN PAD: S.S.A.)
	2"x4" GANG BOX WITH THREE (3) SEPARATE CAT-5E CABLES TO REGISTER #2 (REGISTER: PIN PAD: S.S.A.)
	2"x4" GANG BOX WITH THREE (3) SEPARATE CAT-5E CABLES TO REGISTER #3 (REGISTER: PIN PAD: S.S.A.)
	2"x4" GANG BOX WITH THREE (3) SEPARATE CAT-5E CABLES TO REGISTER #4 (REGISTER: PIN PAD: S.S.A.)

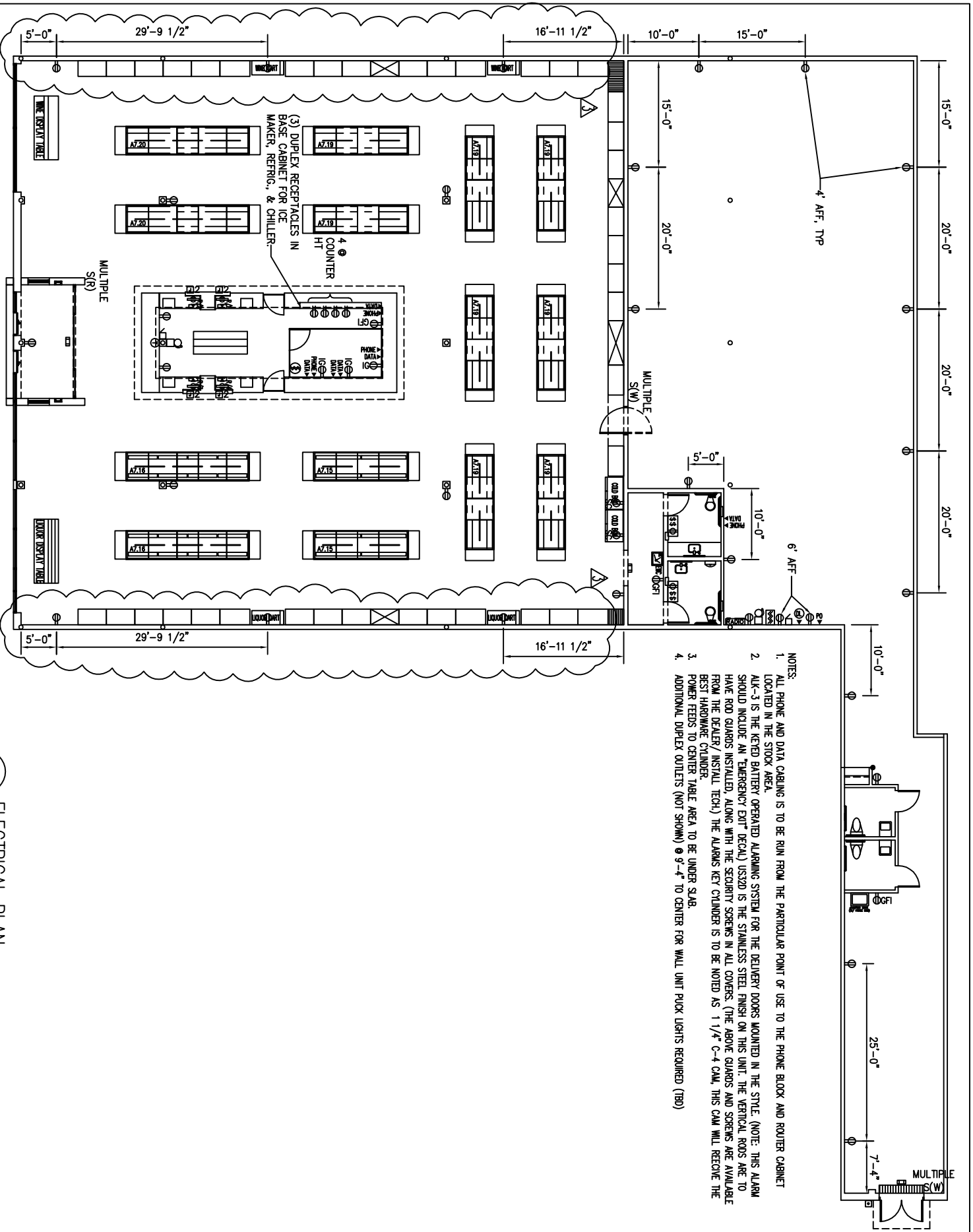

1 ELECTRICAL PLAN  
E-1 1/8"=1'-0"

ROOM FINISH SCHEDULE

NO.	NAME	FLOOR	WALLS	BASE	CEILING	CEILING HGT.	REMARKS
100	SALES AREA	F2/F3/4	PRODRYWALL	WNTL	ACT.	11'-0"	P-LAM AT VESTIBULE WALLS
		F3/6/7	P-LAM	PRODRYWALL	PRODRYWALL		
101	WHOLESALE AREA	F9	PRODRYWALL	WNTL	PRODRYWALL		OPEN TO STRUCTURE ABOVE
102	VESTIBULE	F1	P-LAM	WNTL	P-LAM	10'-0"	
103	OFFICE	F3	P-LAM	WNTL	ACT.	11'-0"	
104	TABLE AREA	F5	P-LAM	WNTL	ACT	10'-0"	
105	MEN'S ROOM	F7	P-LAM	WNTL	ACT	8'-0"	SINK WALL ONLY - V.C.C. ABOVE BRICKSPASH, P-LAM BELOW
			P-LAM	WNTL	ACT		
106	WOMEN'S ROOM	F7	P-LAM	WNTL	ACT	8'-0"	SINK WALL ONLY - V.C.C. ABOVE BRICKSPASH, P-LAM BELOW
			PRODRYWALL	WNTL	ACT		
107	ENTRY	F7	PRODRYWALL	WNTL	ACT	9'-0"	COMMON AREA

SYMBOL	FLOOR COVERINGS - RETAIL, WHOLESALE, RESTROOMS
F1	MATS, INC. SUPREME NOP BLACK WALNUT COLOR - FULL COVERAGE
F2	ARMSTRONG-NATURAL CREATIONS-EARTH CUTS TP511/HAVEN STONE/ GREY PEARL
F3	INTERFACE FLOOR, SUPER FLOOR, STYLE 6090002504, 609164, PACIFIC SUNSET
F4	INTERFACE FLOOR,SUPER FLOOR,STYLE 6090002504, 609153, MEDITERRANEAN
F5	ARMSTRONG-NATURAL CREATIONS-ARBORPART TP029/WEATHERED OAK/GOLDEN BROWN
F6	ARMSTRONG NATURAL CREATIONS EARTH CUTS TP507, COLOR WASH, GOLD
F7	ARMSTRONG-NATURAL CREATIONS-ANYSIX TP746/STRAND CORN/CHAMPAGNE
F8	ARMSTRONG NATURAL CREATIONS EARTH CUTS TP506, COLOR WASH, BROWN- NOT USED
F9	ARMSTRONG EXCELON VCI - 51805 "CAMEL BEIGE

WALL PAINT, COLORS - RETAIL
BENJAMIN MOORE - ORANGE BLOSSOM - 2168-30 = WINE AREA
BENJAMIN MOORE - ELECTRIC BLUE - 2061-40 = SPIRIT AREA
BENJAMIN MOORE - SPLIT PEA - 2146-30 = PREMIUM WINE AREA
BENJAMIN MOORE - HEPPLE WHITE IVORY - HC-36 = TABLE AREA
WALL PAINT COLOR-STOCK
BENJAMIN MOORE - HEPPLE WHITE IVORY - HC-36
----THROUGHOUT----
WALL COVERING/PAINT,COLORS-RESTROOMS
BENJAMIN MOORE - WILMINGTON TAN - HC-34
VINTL WALLCOVERING, WOLF GORDON, BONAIRE, OLIVEBNR 7-3260 MENS
VINTL WALLCOVERING, WOLF GORDON, BONAIRE, PUMPKIN BNR 7-3255- WOMENS
SOLID SURFACE TOPS: CORIAN "RAFITA"

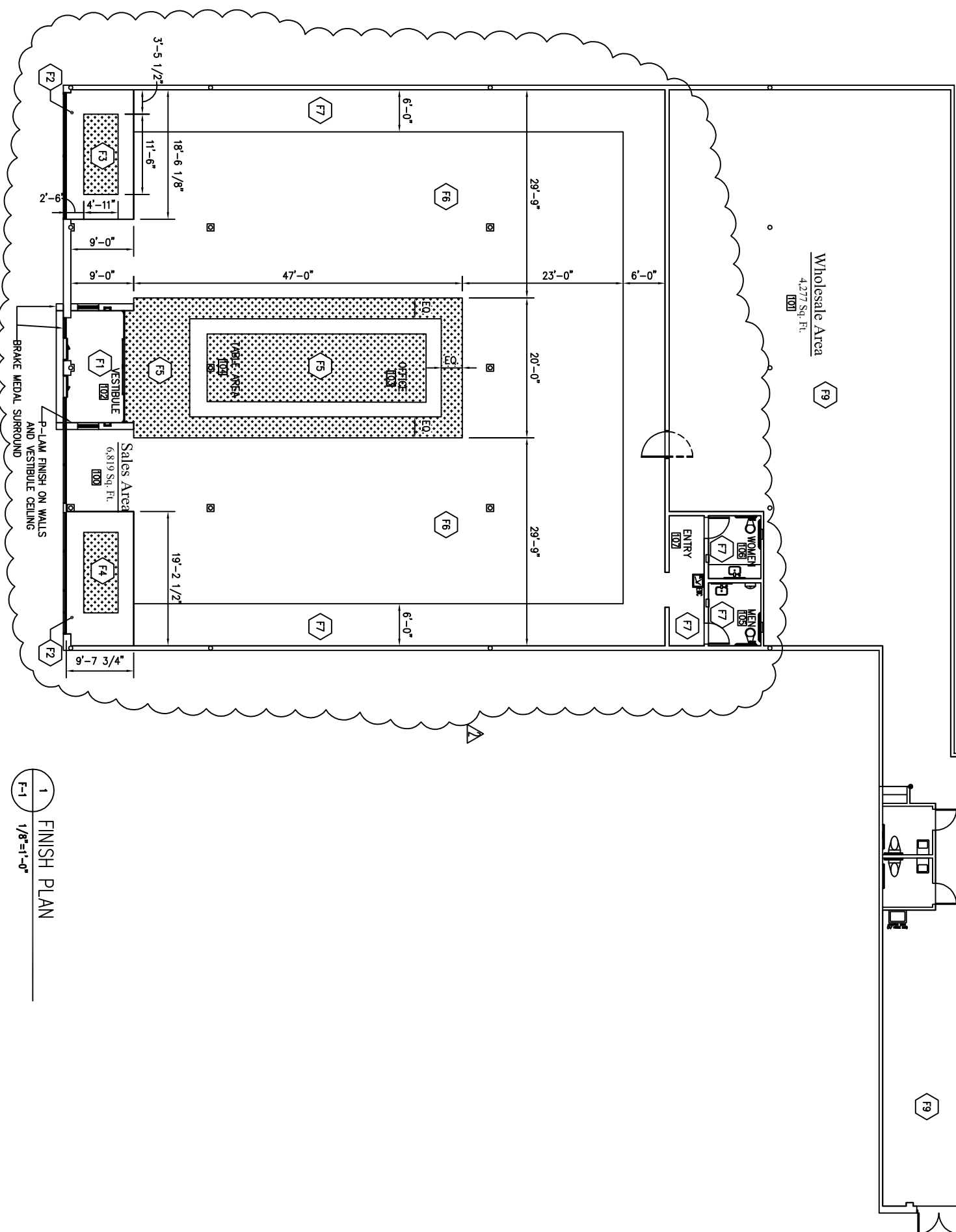

NOTE:  
 1. THIS DRAWING ILLUSTRATES THE GENERAL DESIGN CONCEPT. CONSTRUCTION DOCUMENTS MUST BE PREPARED BY A DESIGN PROFESSIONAL LICENSED IN PENNSYLVANIA.  
 2. ALL DIMENSIONS AND EXISTING CONDITIONS MUST BE VERIFIED AT THE PROJECT SITE PRIOR TO THE PREPARATION OF CONSTRUCTION DOCUMENTS AND PRIOR TO CONSTRUCTION.  
 3. COMPLIANCE WITH STATE AND LOCAL BUILDING CODES, ZONING REGULATIONS AND THE REQUIREMENTS OF THE AUTHORITIES HAVING JURISDICTION IS THE RESPONSIBILITY OF THE DESIGN PROFESSIONAL WHO WILL PREPARE THE CONSTRUCTION DOCUMENTS.

1 FINISH PLAN  
 F-1 1/8"=1'-0"

## Exhibit J—Premium Specifications - STORE

December 18, 2014

### Section One—General Requirements

#### 1.1 Scope

- 1.1.1 The specifications cover all labor, materials, equipment and installation for the proposed retail store located at [REDACTED], as specified herein and shown on the Pennsylvania Liquor Control Board (PLCB) drawings, and are subject to the times, terms and conditions of the lease and any extension or renewals thereof.
- 1.1.2 The Net Usable Square Footage of the premises is [REDACTED] SF, and is subject to upward or downward adjustment upon final field measurement. The Interior Frontage of the premises is [REDACTED].

#### 1.2 Drawings

- 1.2.1 General—The PLCB will provide preliminary drawings to the Lessor showing the general layout of the space. These drawings shall form part of this specification and may be used by the Lessor and his architect to develop a final set of architectural working drawings. Should modifications to the PLCB drawings be necessary to comply with applicable building codes, the PLCB's Construction Manager shall be notified.
- 1.2.2 Scaling—The PLCB drawings are not to be scaled for dimensional information. Dimensional questions of any kind, along with any discovered conflicts or discrepancies related to same, shall be brought to the attention of the PLCB before proceeding with the work in question.
- 1.2.3 Drawings—The PLCB drawings are noted as "Store No. XXXX", and include the following sheets: A-1 "Floor Plan"; A-2 "Reflected Ceiling Plan"; D-1 "Demo Plan"; E-1 "Electrical Plan"; and, F-1 "Finish Plan". All plans are dated X/XX/XX and last revised X/XX/XX.
- 1.2.4 Submittals—Before the Work begins, the Lessor's final architectural working drawings showing site location (plot plan if necessary), building elevation (including signage), general floor plan, rest room locations, electrical and lighting layouts, location of heat/ventilation diffusers and any miscellaneous work shall be submitted to the PLCB's Construction Manager for approval.

#### 1.3 Miscellaneous Requirements

##### 1.3.1 Definitions

- 1.3.1.1 "Drawings"—This shall be the term used throughout these specifications to denote the PLCB Drawings forwarded to the Lessor as described in 1.2.2.
- 1.3.1.2 "Construction Manager"—This shall be the term used throughout these specifications to denote the PLCB's designated management staff liaison with the Lessor for all on-site construction activities.
- 1.3.1.3 Abbreviations—Certain terms used throughout these specifications are denoted by abbreviations, each of which are given parenthetically with its respective term's first usage. Terms include, but may not be limited to, "Pennsylvania Liquor Control Board", "Pennsylvania Department of Labor and Industry", "Americans with Disabilities Act", "Uniform Construction Code", and "International Energy Conservation Code".
- 1.3.2 General—All work specified herein and other incidental work necessary to prepare this building for use as a Fine Wine & Good Spirits retail store shall be performed per the requirements of the PLCB and to the satisfaction of the Construction Manager. If there is a conflict between this Exhibit and the Drawings, this Exhibit shall prevail.
- 1.3.3 Regulations and Permits—The Lessor shall comply with all requirements of the Pennsylvania Department of Labor and Industry (L&I) pertaining to fire, safety, and other hazards. Requirements of all laws, rules, regulations, and zoning permits; use and/or occupancy requirements, and fees, if any, (including any annual sign fees) of city, township, borough, county and state departments shall be the responsibility of the Lessor. All phases of preparation shall be

followed and all work carried out in strict accordance with such requirements, even though each item involved not be necessarily specified herein or shown on the Drawings. The Lessor shall comply with all requirements of Pennsylvania's statewide building code, generally known as the Uniform Construction Code (UCC) 2009, including all subsequent amendments, as well as all applicable state and federal codes and regulations pertaining to the Americans with Disabilities Act (ADA), latest adopted editions.

- 1.3.4 Occupancy Permit—Lessor shall place the Occupancy Permit issued by L&I or local authority in the space and submit a copy to the Construction Manager before the PLCB takes possession.
- 1.3.5 Materials and Workmanship—All materials and equipment being incorporated into the Work shall be new unless otherwise specified. In instances where materials and equipment are existing and proposed to be re-used as a part of the Work, approval from the Construction Manager is required. All materials and equipment being re-used shall be thoroughly cleaned and refurbished to a like-new condition. Said materials and equipment are to be in good working order. All Work to be completed in a neat and workmanlike manner.
- 1.3.6 Finishes—All colors, types and textures of finishes must be approved by the Construction Manager. Such approval shall not be unreasonably withheld.
- 1.3.7 Conditions Affecting the Work—The Lessor shall be responsible to verify all conditions and measurements of the site when the tenant improvement work commences. All discrepancies discovered with the field measurements shall be immediately reported to the PLCB.
- 1.3.8 Security—The Lessor shall provide adequate security on any/all exposed openings as required during renovations or construction. Storeroom security shall meet approval of Construction Manager. Any electronic surveillance/detection devices shall be installed by the PLCB as deemed necessary.
- 1.4 Energy Efficiency Requirements—All design criteria pertaining to the energy use of the structure shall meet or exceed the requirements of the International Energy Conservation Code (IECC), latest adopted edition.
- 1.5 Project Close-out
  - 1.5.1 Punch List—At the time of substantial completion of the Work, and at a time agreeable to the Lessor and the PLCB, a final walk-thru inspection will be conducted, and a Punch List generated identifying incomplete and unsatisfactory work. Unless otherwise agreed to by the PLCB, all Punch List work shall be satisfactorily completed within two weeks of the walk-thru inspection.
  - 1.5.2 Warranty & Operations Manual—Lessor shall provide a Warranty & Operations manual to the PLCB covering the work performed. Manual materials should include instructional care and maintenance data, and any applicable warranties.
  - 1.5.3 As-Builts—Lessor shall provide “as-builts” or “record” drawings to the PLCB. Drawings shall reflect all changes made during the course of the project and confirm actual field dimensions.
  - 1.5.4 Training & Orientation—Lessor shall provide training and orientation to the PLCB following substantial completion of the project at a time agreeable to the PLCB. Topics shall include all mechanical and electrical equipment and devices covering the start-up, programming, maintenance, shut-offs, etc. of all.

## Section Two—Demolition

- 2.1 General—Provide all labor, material and equipment necessary to complete the select demolition work as required. Demo work to include, but is not necessarily limited to the following: 1) xxxxx; 2) xxxxxxx; and, 3) xxxxxx. Extent of work shall be as required to achieve the intended final results. Protect all finish surfaces to the fullest extent possible. Clean up daily. Trash and debris to be disposed of properly off site.
- 2.2 Protection—Protect all finish surfaces to the fullest extent possible. Prior to commencement of the work, filter all return air grilles to prevent dust infiltration. Change filters as required during the course of the work. Filtering should remain in place until Substantial Completion.



### Section Three—Slab & Flooring

- 3.1 General—The floor shall be reinforced concrete, trowel finished and level throughout, to support a minimum of 150 lb live load per square foot and withstand usage of store's two-wheel hand trucks, four-wheel stock carts and pallet jacks. All low spots are to be filled in, and all high spots are to be ground down smooth, ready to receive finished flooring. Level tolerance at the center table area is +/- 1/16" in 10'. Level tolerance in the rest of the retail area and stock area is +/- 1/8" in 10'.
- 3.2 Preparation—Following the removal of existing floor coverings as may be required to produce the intended results, thoroughly clean the existing concrete by removing all glue and other contaminants. Provide skim coating and flash patching operations as needed for the proper installation of the new flooring. Insure that all control and construction joints are properly filled flush to the slab surface and are in a stable condition.
- 3.3 Finished Flooring
- 3.3.1 Coordination—Symmetry is critical for the finish flooring at the center table area and table displays at the front windows. Coordinate lay-out with the PLCB prior to commencement of installation.
- 3.3.2 Installation—Installation of the luxury vinyl tile shall be in strict accordance with Armstrong's guidelines for "Installation System of Commercial Luxury Vinyl Tile". Insure that the proper adhesive is used for this application. Roll the tile in both directions within thirty minutes after installation using a 100-lb. roller as specified.
- 3.3.3 Sales Area—The floor shall be finished with 1/8" thick luxury vinyl tile, Natural Creations by Armstrong World Industries, Inc. Flooring colors include: ArborArt #TP029 "Weathered Oak Golden Brown" in 8"x36" planks; Earthcuts #TP507 "Color Wash Gold" in 18"x18" squares; Mystix #TP746 "Strand Cork Champagne" in 18"x18" squares; and, EarthCuts #TP511 "Haven Stone Gray Pearl" in 12"x12" squares. Carpet tiles shall be from the Super FLOR series by InterfaceFLOR, LLC. Colors are: #609164 "Pacific Sunset"; and, #609153 "Mediterranean", both in 50 cm x 50cm squares. Layout shall be specified on Drawings.
- 3.3.4 Toilet Rooms—The floor shall be finished with 1/8" thick luxury vinyl tile, Natural Creations by Armstrong World Industries, Inc. Flooring color shall be Mystix #TP745 "Strand Cork Champagne" in 18"x18" squares.
- 3.3.5 Wholesale Area—Lessor shall provide finished concrete surfaces degreased and cleaned of all contaminants, and shall apply a minimum of two uniform coats of Dress & Seal WB 25 by L&M Construction Chemicals to achieve a smooth glossy finish. Preparation of slab surfaces to be as specified by sealer manufacturer. Allow adequate drying time between coats as per manufacturer's recommendations.
- 3.3.6 Vestibule—The Vestibule floor mat material shall be "Supreme Nop" as manufactured by Mats, Inc. The material shall be 7/16" thick, laid for full coverage. The color shall be "Black Walnut".
- 3.3.7 Vinyl Cove Base—Johnsonite #44 Dark Brown 4" vinyl cove base shall be installed in all areas receiving vinyl tile flooring, including installation on the following items provided by the PLCB: Center Table / Checkout Area; Premium Wine Wall Unit; Stockroom Door Unit; and, Fixed end bases on the "Stock Gondola" fixtures. Base is not required on walls directly behind perimeter wall units in the Retail area that are hidden from view.
- 3.3.8 Vinyl Transition Strips—All abutting dissimilar materials should incorporate a vinyl transition strip of design to suit application. Strips to be by Armstrong or Tarkett Flooring, or approved equal. Color as selected by the PLCB.
- 3.3.9 Finishing and Protection—All vinyl flooring shall be cleaned and polished prior to turnover as per manufacturer's recommendations. Prior to polishing, apply a thorough coat of Armstrong's S-495 high quality stain-resistant sealer as per manufacturer's instructions. Follow the sealer application with Armstrong's S-480 Commercial Floor Polish. The Luxury Solid Vinyl used in the Retail area and Toilet Rooms shall receive four coats of polish. Allow adequate drying time between coats as per manufacturer's recommendations.

### Section Four—Walls

- 4.1 Perimeter Walls—Masonry block walls exposed to the outdoor elements shall be sealed, painted and insulated. All exterior walls shall be insulated to a minimum R-13 rating and have a vapor retarder of 1 perm or less. Insulation and vapor retarder

shall extend to the horizontal roof or ceiling plane of insulation to create a tight envelope. All perimeter wall openings shall be sealed and insulated. Walls dividing leased area from any adjacent space shall be of full height from floor to underside of roof.

- 4.2 Interior Walls—Any non-load bearing walls constructed shall be of 20 or 25 gauge steel studs, 16" O.C., and 5/8" drywall taped and spackled with a minimum three-coat finish made ready to receive paint. Load bearing walls will need to be designed by a licensed engineer registered in the state of Pennsylvania. Toilet Room walls shall use Moisture Resistant board. All interior walls shall extend a minimum of six inches (6") above the highest adjacent ceiling, unless otherwise dictated by Code.
- 4.3 Painting—All paintable surfaces, including those behind wall unit fixtures, shall receive one primer coat and two finish coats of Benjamin Moore latex paint, satin/eggshell finish, or equal as approved by the PLCB. Locations of various colors shall be as directed by the PLCB.

### Section Five—Entrances and Storefront

- 5.1 General—Lessor shall provide front elevation sketches and description of materials to be utilized to the Construction Manager for approval.
- 5.2 Sliding Automatic Entrances—Provide complete automatic aluminum entrance system of type and size as indicated on the Drawings. Manufactured door unit shall include concealed operator, header with roller track, carrier assemblies, framing jambs, sliding door panels, sidelites, activation, safety devices and accessories needed for a complete installation. Doors to be bi-parting, Type 110 Profiler Series 2000B Elite with slide/swing breakout panels for emergency egress as manufactured by Horton Automatics, or approved equal. The exterior aluminum framing color shall match that of adjacent spaces. The interior doors and associated framing are to be colored dark bronze. The framing should be capable of receiving up to 1" insulated glass. Doors shall be equipped with 3-point locking for bi-parting doors. Furnish cylinder locks with pivot-type maximum security bolt MS1850A, bolt size 5/8" x 1-3/8" with 1-3/8" throw, as manufactured by Adams Rite Manufacturing Co. capable of accepting a Best Lock key system. Lessor shall provide Best Lock cylinder; PLCB shall provide Best Lock core. Aluminum threshold to be low-profile and ADA approved.
- 5.3 Storefront Framing—Storefront shall be constructed of anodized aluminum framing in a finish to match adjacent spaces and as indicated on the Drawings. Tubular framing at doors shall be reinforced to prevent forced entry. Framing to be thermally broken as manufactured by Kawneer Co., Inc. or approved equal. Framing to be 2" face x 4-1/2" depth, in compliance with L&I and all other authorities having jurisdiction for installation and safety. Framing to be compatible with the sliding automatic entrance framing.
- 5.4 Glass & Glazing—Provide, install and maintain commercial grade, energy efficient thermal pane window and door glass. Provide tempered glass where required by code. All glass on the exterior face of building shall be 1" thick, 1/4" panes with a minimum of 1/2" air space between the two 1/4" pieces, "Low-E" coating applied, and a maximum overall U-0.5 rating. Glass shall comply with all L&I and local standards for installation and safety compliance. All exterior glass shall have a shading factor as approved by the Construction Manager, taking into consideration orientation and overhangs. Interior vestibule glass shall be 1/4" clear. Provide "Low-E" certification to the PLCB upon completion of the Work. Should inclusion of "Low-E" glass not be practical, consideration will be given to use a window film on the front glass units. Submit samples to the PLCB for approval.

### Section Six—Wood,Plastics & Misc. Specialties

- 6.1 Rough Carpentry—Install all wood studs, furring, blocking, nailers, backing, and hardware as required. All wood contacting concrete or masonry surfaces is to be pressure treated. Provide rough hardware, nails, bolts, fasteners, anchors and connectors as required to complete the Work. Provide backboard material for mounting of utility equipment as may be required.
- 6.2 Blocking—Provide blocking in walls at all locations that require additional wall support, such as for fire extinguishers, grab bars, mirrors, lavatories, toilet accessories, finish hardware, etc. In addition, two rows of 2x6 continuous wood blocking shall be required for the perimeter wall unit fixtures, installed at 96" and 105.5" above finished floor to top of blocking.
- 6.3 Finish Carpentry—Finish carpentry shall conform to American Woodwork Institute criteria.
- 6.4 Coat Rack & Shelf—Provide a coat rack with shelf above in the Closet as indicated on the Drawings.

- 6.5 Plastic Laminate—Furnish and install plastic laminate covering on both sides of each sidewall in the Vestibule, and on the Vestibule ceiling, over a plywood substrate. Laminate to be “Zebrano” #F9011 by Formica, Inc.
- 6.6 Solid Surface Material—Furnish and install solid surface countertops in each Restroom as indicated on the Drawings. Material to be either “Raffia” by Corian, “Bone” #003 by Meganite, Inc., or approved equal.
- 6.7 Column Covers—Provide stainless steel column covers at all perimeter and interior columns exposed to the Retail sales floor. Column covers shall extend to a height of 48” above finish floor. Material to be 16 gauge in a brushed finish. Install with concealed clip angles to the smallest overall dimensions possible unless noted otherwise.

### Section Seven—Doors and Hardware

- 7.1 Hollow Metal Doors—Hollow metal doors shall be 18 gauge, 1-3/4” thick, flush, with an expanded polystyrene core for exterior doors. Doors to be as manufactured by Republic Doors and Frames, or approved equal, and sized as indicated on the Drawings. Exterior hollow metal doors shall be galvanized.
- 7.2 Hollow Metal Frames—Hollow metal frames shall be 16 gauge, as manufactured by Republic Doors and Frames, or approved equal. Exterior hollow metal frames shall be galvanized.
- 7.3 Wood Doors—Interior doors shall be pre-finished solid core wood as manufactured by Mohawk Door Company, 2000 Premium Pre-finished Collection Oak series in a Walnut finish, or approved equal.
- 7.4 Hardware—Provide all hardware in US26D Satin Chromium finish. Unless noted otherwise, metal exit doors to be “Exit Only” with compatible hardware. Hardware to include, but is not necessarily limited to the following: Exit device; Overhead closer; Full mortised NRP hinges; Threshold; Security alarm; and, Weatherseal. Interior doors to receive the following: Overhead closer; Full mortised NRP hinges; and, Lever latchset. Toilet Room doors shall include a lever privacy lockset in lieu of a latchset.
- 7.5 Traffic Doors—Provide a double-acting traffic door between Retail and Stock areas. Door to be “Easy-Swing” type SCP-6 as manufactured by Eliason Corporation, or approved equal. Door to have a dark brown high impact thermoplastic finish, and include a 9”x24” ADA approved view window and 36” high stainless steel base plates on each side. Door size to be 44” x 84”. Jamb and header to be structural steel channel.
- 7.6 Painting—Hollow metal doors and frames shall be primed and painted with a two-coat semi-gloss finish. Color to be #SW-6076 “Turkish Coffee” by Duron Paint or approved equal.

### Section Eight—Delivery Facilities

- 8.1 Delivery Facilities—Where delivery facilities are not the same grade level as inside finished floor elevation, the Lessor shall provide a loading dock area. Loading dock surface shall match the interior floor elevation and not exceed a difference of 4'-0" to the paved surface. Delivery area shall be paved to withstand weight of tractor trailer of 25 tons. Area shall be designated for PLCB use only. Provide 6” thick laminated rubber bumpers as required, mounted to accommodate the various delivery trucks to be used at this location. Signage, if required, shall be furnished and installed by the Lessor.

Note: Merchandise is transferred from a tractor trailer directly to the interior of the store. This makes tractor trailer access to the delivery door(s) imperative.

- 8.2 Delivery Doors—Furnish and install rear delivery doors. Door opening shall be 6'-0” x 7'-0” consisting of one pair of 3'-0” x 7'-0” insulated metal doors and frame as manufactured by Republic Doors and Frames or approved equal. Doors shall be 1-3/4” thick, full flush, 18 gauge, insulated to an R-7 rating with an expanded polystyrene core. Frame shall be constructed of 16 gauge material and reinforced for hinges, strikes, and closers. All material shall be galvanized steel and include a factory prime finish. Provide product data for approval. These doors are to be “Exit Only” with compatible hardware.
- 8.3 Delivery Door Canopy—Provide fabric or metal canopy over delivery door(s) to extend a minimum 1'-2" to either side of the door frame. Canopy shall project at least 4'-0" from building to divert water away from delivery/pick-up area. Provide product data for approval and install according to Drawings.

- 8.4 Hardware—Furnish and install Stanley PHI Apex Exit Device (Precision Hardware) 2200 Series Vertical Rod Exit Device with alarm, Model #2201ALK-3 x US26D x door size on the active leaf. The vertical rod is to have a rod guard installed and security screws installed in all the unit's covers. All guards and screws shall be from the dealer/installation technician. The key cylinder shall be 1-1/4" C-4 Cam and receive a Best Hardware core. The device shall include "Emergency Exit" decal. Other door hardware shall include non-removable pin hinges, surface mounted closer (active leaf), metal astragal (active leaf), hold-open devices, kick plates, peep-hole, two slide bolts (inactive leaf), weather-stripping, and 1/4" low-profile threshold, which are to be coordinated with door size for proper fit. For maximum security, the metal astragal shall be an integral component of the door, with permanent connection points within the concealed door edge. All hardware shall be US26D Satin Chromium finish.
- 8.5 Air Curtain—Furnish and install one air curtain above the delivery doors for both insect and environmental protection. Air curtain to be model Star STR2072E-SS as manufactured by Berner International Corp. or approved equal. The unit is to include electric heat. Unit shall be 72" in length, with a stainless steel exterior cabinet.
- 8.6 Miscellaneous—Provide two 6" O.D. concrete-filled posts at delivery area to prevent trucks from damaging door(s) and building (if loading/docking facilities are not available). Posts shall receive two coats rust-proof red or yellow paint.

### Section Nine—Roof

- 9.1 General—Roof shall be constructed in compliance with acceptable trade practices and free from leaks. Investigate the source and cause of all existing stained ceiling tile and make repairs as necessary to insure a watertight condition.
- 9.2 Canopy—Any canopy projection constructed shall be installed to cover sidewalk area or otherwise, as agreed upon by the Construction Manager.
- 9.3 Drains—Roof drains (gutters and downspouts) shall be in compliance with acceptable trade practices and local codes.
- 9.4 Insulation—The ceiling or roof insulation shall have a minimum R-20 rating with a vapor retarder of 1 perm or less and be located at the structural plane of the ceiling. Insulation shall not be installed atop suspended ceiling tile.

### Section Ten—Ceilings

- 10.1 Sales Area—Ceiling shall be 24" x 48" x 3/4" Armstrong Dune "Second Look II" – scored 9/16" angled tegular lay-in tile #2722 with 9/16" Suprafine exposed tee system. The perimeter of the Sales area to be suspended drywall as specified on Drawings. Finished height, tile layout, and tile/drywall transition shall be as shown on the Drawings.
- 10.2 Toilet Rooms—Ceiling shall be 24" x 24" x 5/8" Armstrong Cortega angled tegular lay-in tile #704 suspended on white grid.
- 10.3 Wholesale Area—Wholesale area shall be exposed to roof underside.
- 10.4 Center Raft—Construct the center raft element above the center table area of dimensions, materials, and finishes as specified on Drawings. Coordinate with the PLCB to insure the Raft is centered over the Center Table/Office area. All support structure for the raft, as well as light fixture boxes incorporated within, shall be totally hidden from view.

### Section Eleven—Plumbing

- 11.1 General—All piping shall be lead free. All water lines shall have shutoff valves at the fixture.
- 11.2 Mop Sink—This sink shall be an in-floor unit installed at location specified on the Drawings and equipped with a threaded bibcock for hose attachment. "Splash guards" shall be installed on the surrounding walls.
- 11.3 Hot Water Heater—Install and maintain a hot water heater with capacity of 6 gal. Unit shall meet or exceed all energy-efficient factors. Unit shall be installed above restroom ceiling.

- 11.4 Drinking Fountain—Install and maintain drinking fountain, Oasis Versacooler II Split-level Water Cooler P8ACSL, or approved equal. Unit denoted by "EWC" on drawings. Installation must be ADA-compliant and accompanied by electrical outlet designated on drawing, water and drain plumbing, and wall splash guard.

### Section Twelve—Toilet Rooms

- 12.1 General—Construct Toilet Rooms as specified on Drawings. Toilet Rooms shall be in accordance with Act 235 and its Amendments and the ADA.
- 12.2 Doors—Toilet Rooms shall have pre-finished solid core wood doors, 3'-0" x 6'-8" minimum dimensions, operable by a single effort. Each door shall include a lever handle, closer, hinges and privacy lockset.
- 12.3 Fixtures—Each Toilet Room shall have white fixtures, including: One 1.6 GPF wall-hung toilet with flush valve (assuming adequate water supply); One 0.5 GPM under-mount sink; and, One 1.0 GPF wall-hung urinal in the Men's Room.
- 12.4 Accessories—Each Toilet Room shall be equipped with the following accessories as manufactured by Bobrick Washroom Equipment, or approved equal, unless noted otherwise: Waste Receptacle B-3644; Toilet Tissue Dispenser B-6977; Robe Hook B-6727 (back of door); Mirror B-165 2436; Grab bars as required in satin finish with peened gripping surface; Hard Roll Paper Towel Dispenser #09996, colored Smoke, by Kimberly-Clark; and, Foam Soap Dispenser #4612910, Reliable brand furnished by Xpdex LLC, 1250 ml Black. All accessories and mounting locations of same shall be in compliance with ADA and authorities having jurisdiction.
- 12.5 Exhaust Fan—Furnish and install Nutone #8814R fixture on separate switch and ducted to the outdoors in each restroom. Ventilation requirement is 110 CFM.
- 12.6 Signage—Furnish and install toilet room identification tactile signage in compliance with ADA Accessibility Guidelines. Signs to be as manufactured by Advance Corporation, Braille-Tac Division, Cottage Grove, MN, or approved equal. Background color to be #238 "Chocolate Brown"...lettering color to be #237 "Tan".

### Section Thirteen—Electrical

- 13.1 General—The Lessor shall have all electrical work designed by a professional engineer registered in the Commonwealth of Pennsylvania. Furnish and install all necessary electric wiring, outlets, wall receptacles, junction boxes, switches, light fixtures, signal system, and circuit breaker panel with appropriate metering device. The Lessor shall furnish Underwriters Laboratories certificate upon completion. Phone and Data wiring shall be as required per Drawings with proper terminations.
- 13.2 Coordination—Provide cutting, trenching and patching of slab areas as may be required for electrical installations. Electrical Contractor shall coordinate his Work with the installation of the fixtures, tables and displays being furnished and installed by the PLCB. LED lights pre-installed in the category sign boxes on top of the wall units to be tied together, powered and switched separately by the Electrical Contractor. Provide all necessary wiring runs and connections for equipment at the center table area. Power to the center table area shall be run under the slab unless approved otherwise by the PLCB. Pendant and accent light fixtures over display tables and gondolas are to be centered over the final positioning of each display unit.
- 13.3 Service—The electrical service shall be sized to adequately handle the design loads of the PLCB space, including built-in factors of safety as recommended by the National Electric Code or other authorities having jurisdiction, but not less than 200 amp. The main entrance switch and multi-circuit panel shall be installed at a location in the storeroom area designated on Drawings or otherwise agreed upon.
- 13.4 Receptacles/Switches
- 13.4.1 Wall Duplex Receptacles—Provide and install receptacles as described and in locations shown on the Drawings. Mounting heights for receptacles shall be as indicated on the Drawings. Mount puck light receptacles horizontally. Do not install duplex outlets in the same stud space on opposite sides of a partition/wall.
- 13.4.2 Router Cabinet Receptacle—Provide and install one twist-lock receptacle dedicated for the router cabinet in the Wholesale Area. Device to be type #HBL2310 by Hubbell.

- 13.4.3 Wall Junction Boxes—Provide and install wall junction boxes as described and in locations shown on the Drawings.
- 13.4.4 Ceiling Junction Boxes—Provide and install junction boxes above the ceiling as described and in locations shown on the Drawings.
- 13.4.5 Light Switches—Provide and install switches as required and in locations as indicated on the Drawings.
- 13.4.6 Finishes—All switches and receptacles to be colored Brown. All switch, receptacle and other miscellaneous device plates are to include a Stainless Steel finish.
- 13.5 POS Wiring
- 13.5.1 Electric—Provide one (1) 120v dedicated circuit at each register (4 total). The designated junction boxes shall contain two separate lines of 12/2 gauge wire on single-pole 20 A circuits. At least one shall have an isolated ground, a reading of 117 V  $\pm$  10% and, when switched off, a reading of 0  $\Omega$ . The other line shall also have a ground. Run power throughout the check-out area as required.
- 13.5.2 Ethernet—Provide three (3) separate CAT-5E cables to each register (one for the register; one for the pin pad; and, one for the SSA panic button). Run cables to the router cabinet in the Wholesale Area. Lessor to provide cable terminations at the registers. Jack locations to be determined by the PLCB. Cable terminations and final connections at the router cabinet will be by the PLCB.
- 13.6 Office Area Wiring
- 13.6.1 Electric—Provide a total of four (4) 120v dedicated circuits in the Office Area (one for the printer; one for the computer; one for the camera monitor; and, one for “extra”). The designated junction boxes shall contain one dedicated line of 12/2 gauge wire on a single pole 20A circuit. The line shall have an isolated ground, a reading of 117 V  $\pm$  10% and, when switched off, a reading of 0  $\Omega$ . An additional separate isolated covered ground wire must be provided. Run power throughout the Office Area as required.
- 13.6.2 Ethernet— Provide six (6) separate CAT-5E Ethernet cables to the Office Area (one for the printer; one for the computer; one for the camera system; one for the SSA panic button; one for the phone and fax; and, one for “extra”). Run all cables to the router cabinet and phone block in the Wholesale Area as required. Lessor will provide all cable terminations in the Office Area. Jack locations to be determined by the PLCB. Cable terminations and final connections at the router cabinet will be by the PLCB.
- 13.7 Wine Tasting Wiring
- 13.7.1 Electric—Provide a total of seven (7) 120v circuits in the Wine Tasting Area (four convenience outlets at the counter; one for the ice maker; one for the mini refrigerator; and, one for the wine chiller). Run power throughout the Wine Tasting area as required.
- 13.7.2 Ethernet—Provide two (2) separate CAT-5E cables at the wine tasting counter (one for a phone; and, one for a computer). Run all cables to the router cabinet and phone block in the Wholesale Area as required. Lessor will provide all cable terminations in the Wine Tasting Area. Jack locations to be determined by the PLCB. Cable terminations and final connections at the router cabinet will be by the PLCB.
- 13.8 Miscellaneous Wiring—Provide two (2) separate CAT-5E cable runs to the Wholesale counter in the Wholesale Area (one for a phone; and, one for the SSA panic button). Lessor will provide terminations at the counter. Cable terminations and final connections at the router cabinet will be by the PLCB.
- 13.9 Access Panels—Provide adequate metal access panels as required for servicing and testing of equipment and devices, and for access to all hidden shut-off valves. Coordinate all locations with the PLCB.

## Section Fourteen—Lighting

- 14.1 General—All systems shall be designed by a professional engineer registered in the Commonwealth of Pennsylvania. The number of fixtures for general overhead lighting shown on the Drawings is only an estimated quantity. The professional engineer shall dictate the number of fixtures required to meet the illumination levels specified herein. Final design shall meet the requirements of the IECC.
- 14.1.1 General Sales Area—Standard retail area illumination shall be 2' x 2' LED fixtures, type LR24-32SKA35 by Cree Lighting, for the type F-8 fixtures. Average illumination at 3'-0" above finished floor shall be 55 ft-c maintained while consuming a maximum of 1.8 W per square foot. Location of all primary ceiling fixtures, as well as any additional down-lights and track-lights, shall be as designated on the Drawings. All light fixtures shall have energy-efficient electronic ballasts with a minimum power factor of 90%. Lamps shall be as designated on the Drawings. Use compact fluorescent lamps in the type F6C pendant fixtures.
- 14.1.2 Wholesale Area— Average illumination at 3'-0" above finished floor shall be 30 ft-c maintained while consuming a maximum of 0.66 W per square foot. Fixtures shall be 48" long 2-tube fluorescent T8 general purpose strip lights, type C232MV. All fixtures shall be installed at the same level and operated by occupancy sensors.
- 14.1.3 Toilet Rooms—Furnish and install in each Restroom the lighting fixtures shown on the Drawings. Lights shall be controlled by an occupancy sensor.
- 14.1.4 Night Lights—A minimum of four fixtures shall be designated as continuous night lights in the Retail area and two fixtures in the Wholesale area, and placed on a separate circuit.
- 14.1.5 Emergency Lighting—Furnish, install and maintain an automatic, maintenance-free, emergency lighting system as required by the authority having jurisdiction. This system shall be integrated with the recessed light fixtures whenever possible.
- 14.1.6 Exit Lighting—Furnish and install ELR-R clear acrylic, recessed mounted, edge lit, one-sided exit sign with red LED, white housing by The Exit Light Company. This lighting shall be circuited with the emergency lighting.
- 14.1.7 Switches—Switch locations and level of light fixture control to be approved by the PLCB prior to start of installation.
- 14.1.8 Specialty Lighting—Furnish and install a total of six (6) wall sconces as directed. The premium wall unit in the Retail Area shall receive two P7081-20 sconces by Progress Lighting. Each Toilet Room shall receive two P7081-09 sconces by Progress Lighting.
- 14.1.9 Display Accent Lighting—Furnish and install all accent lighting as shown on the plans. Symmetry is critical at all display areas. Coordinate final locations with the PLCB prior to installation.
- 14.2 Entrance—Provide a minimum of 10 ft-c consuming a maximum of 10 W per square foot of canopied area at front entrance to match existing decor where applicable. These fixtures and lamps shall also be energy-saving exterior fluorescent with 90% minimum power factor electronic ballasts.
- 14.3 Delivery Door and Exit Door Lights—Provide a vapor-proof light fixture with guard at exterior doors, such as Lithonia model TWL-35S-120-PE-LPI-DBL with accessories TWLMA and TWLWG. Fixtures shall provide a minimum of 20 ft-c and consume a maximum of 20 W per linear foot of door opening.

## Section Fifteen—Heating, Ventilation, and Air Conditioning (HVAC)

- 15.1 General—Furnish, install and maintain a fully automatic forced air (duct) heating system with filters capable of heating the entire space from 0° F outdoor design temperature to 70° F indoor design temperature at prevailing wind conditions. Provide adequate air return to system. Ducts shall be concealed above suspended ceiling and insulated to a minimum R-8 rating when located outside the building thermal envelope. Furnish, install and maintain air conditioning equipment sufficient in capacity to cool the entire space from 95° F outdoor design temperature to 72° F indoor design temperature with maximum 50% indoor relative humidity, supplying a minimum of 15 CFM fresh air per person (average eight). Air conditioning unit shall use

the same duct distribution system as the heating system above the entire leased area. All systems shall be designed by a professional engineer registered in the Commonwealth of Pennsylvania, meeting the requirements of the IECC.

- 15.1.1 Three-Phase Electric Systems—The minimum seasonal energy efficiency ratio (SEER) for three-phase electric central systems shall be 12.0 for units rated at 5 tons and under. For units 6 tons or larger, the minimum energy efficiency ratio (EER) shall be 10.5. A standard rating of 95° F db shall be used.
- 15.1.2 Air-Cooled Heat Pump Systems—The minimum heating seasonal performance factor for air-cooled three-phase electric central air conditioning heat pump systems shall be 7.5 and have a minimum coefficient of performance (COP) of 3.5 at a high temperature rating of 47° F db in the heating mode.
- 15.1.3 Water- or Evaporatively-Cooled Heat Pump Systems—The minimum SEER for water- or evaporatively-cooled central air conditioning heat pump systems shall be 12.0 at a standard rating of 85° F entering-water temperature for water-source and water-cooled equipment and 95° F db outdoor temperature for evaporatively-cooled equipment and have a minimum COP of 4.0 at a standard rating of 70° F entering-water in the heating mode.
- 15.1.4 Combustion Furnaces and Boilers—The minimum thermal efficiency at the maximum rated capacity of combustion furnaces and boilers shall be 80%. All systems shall have mechanically induced draft utilizing outside combustion air.
- 15.2 Toilet Room Heating—If direct line ceiling ducts are not practical, furnish and install electric heaters with separate occupancy-type thermostat control such as Clark model C-1 in toilet room area(s).
- 15.3 Heater Room—If the heating unit is a floor-standing type, it shall be enclosed in a fire-rated room as required by local codes.
- 15.4 Electric Heating—Radiant electric resistance heating shall not be used as a primary heat source.
- 15.5 Utilities—All heating system requirements shall be within the guidelines established by the local utility companies. The Lessor shall install and maintain the appropriate metering system(s) with demand measurement as required by the local utility companies. Minimum amperage shall be increased to a level necessary to provide adequate service.
- 15.6 Thermostat(s)—Lessor shall provide and install 7-day digital, programmable thermostats, type VisionPRO 8000, as manufactured by Honeywell International, Inc., or approved equal. Model of thermostat to be that which is most compatible with HVAC equipment. Location of control(s) shall be as determined by the landlord's engineer, and as approved by the PLCB. There shall be one thermostat per HVAC unit.

## Section Sixteen—Exterior Signage

- 16.1 General—Furnish, install and maintain      complete sets of illuminated channel style letters on the main canopy/fascia. Signage to read, "FINE WINE & GOOD SPIRITS – PREMIUM COLLECTION". This sign shall be of maximum size allowed by local codes and consume a maximum of 0.2 W per square foot of signage.
  - 16.1.1 Timer—Power to canopy/fascia signage shall be controlled through a 24-hour, seven-day timer to be installed and maintained by the Lessor. The location of sign timer shall be in the vicinity of the multi-circuit electrical panel.
  - 16.1.2 Graphics—Electronic art file for sign panel shall be provided by the Construction Manager. Graphic elements otherwise specified may include (but are not necessarily limited to) proportionate letter size, letter spacing, letter shape (font), letter color(s), background color(s), choice of any additional characters, icons, or borders and their proportionate size, shape, specific location and color(s). Submit shop drawings to the PLCB for final approval.
- 16.2 Pylon—If allowed by local codes, furnish, install and maintain store signage, or equal identification as approved by the Construction Manager, on roadway pylon standard. Its size may be based on PLCB's proportionate area of occupancy with respect to other tenants. Non-graphic elements (type of material, method of illumination, etc.) shall be consistent with those of other tenants' pylon signage. Graphics shall be provided by the Construction Manager as specified in 16.1.2.
- 16.3 Under-Canopy Signage—If neighboring spaces feature under-canopy/above-sidewalk tenant identification, furnish, install and maintain store signage, or equal identification as approved by the Construction Manager. Size and other non-graphic elements (type of material, method of illumination, etc.) shall be consistent with those of other tenants' under-canopy signage. Graphics shall be provided by the Construction Manager as specified in 16.1.2.



- 16.4 Awnings—Provide canvas awnings over the windows at the front elevation. Provide mil finished aluminum framing for each awning. Awnings shall be approximately 4'-0" high with a projection from the wall of 2'-0". PLCB logo to be screen printed on each awning. Colors and logo shall be determined by the PLCB. Submit shop drawings to the PLCB for final approval.
- 16.5 Fees—All fees connected to the installation and maintenance of signage shall be the responsibility of the Lessor.

## Section Seventeen—Special Systems

### 17.1 Signal Systems

- 17.1.1 Wireless Annunciator System—Furnish and install an OPTEX Wireless 2000 Annunciator System for each exterior door opening. In addition, provide one sensor for the opening into the Entry of the restrooms. One sensor transmitter TD-20U is required for each of these openings. A minimum of two chime boxes with relays (receivers) RC-20U shall be installed, one for the Retail openings and one for the Wholesale openings as required. Each chime box should have a different chime tone. Receivers are required to have outlets approximately 2'-0" below finished ceiling. Transmitters are located above the doors and are battery operated.
- 17.1.2 Delivery Door Bell—Furnish and install a bell system ("Edward" #740 with #590 transformer) to be connected to a waterproof push button outside the rear delivery door ("Edward" #603). Bell will ring in both the retail and wholesale areas in locations specified on Drawings approximately 2' below ceiling.
- 17.1.3 Interior Buzzer—Furnish and install an Edwards Miniature Lungen Buzzer unit (15-1AB AC/DC) with Edwards 590-series Class 2 signaling transformer mounted as designated on Drawings with 120V duplex receptacle. Run two-strand low voltage buzzer wire from buzzer location to the front cash register area, coiling at least 25' extra above ceiling.
- 17.2 Telecommunications Wiring—Furnish and install material to pre-wire premises, and install necessary modular jacks for phone and data installations as shown on the Drawings. All wiring must be run to the point of demarcation. Final connections and telephones are provided by the PLCB. All wiring must be CAT-5E cable.
- 17.3 Fire Alarm System—If required by code, provide, install and maintain approved fire alarm system in compliance with local building codes and Fire Marshal. System to consists of smoke and heat detectors, horns, strobes and associated control panel. All devices should be ceiling hung. Insure that dedicated phone lines are installed for the monitoring of the central station.
- 17.4 Fire Suppression System
- 17.4.1 Sprinkler System—If required by code, provide, install and maintain an overhead wet-pipe sprinkler system for protection in all areas. Provide semi-recessed heads in the Retail area. System shall be in compliance with the PA Department of Labor & Industry, and all other authorities having jurisdiction.
- 17.4.2 Fire Extinguishers—Provide and install 10 lbs. ABC dry chemical type fire extinguishers as required by the local municipality. Mounting hooks are an acceptable method of installation. Locations should include, but are not necessarily limited to the Office area, and the Stockroom area. Locations in the Retail area shall be approved by the Construction Manager.
- 17.5 Sound System—Furnish and install one Atlas Sound AA35 70V powered mixer amplifier (35W, three-channel), one DST1 AM/FM stereo tuner by Bogen Communications, and three pairs of Speco Technologies Nexus Contractor Series 6.5" 70V metal back-can speakers (SP6NXCTUL). Locations of these components will be specified on Drawings. Furnish and install all necessary wiring between components. Speakers should be run out of the 70V output of the amplifier. The wattage setting in the high-voltage mode of use should be at 3.7W.

- - - END - - -

**APPENDIX D**

**COMMONWEALTH OF PENNSYLVANIA  
REQUIREMENTS**

## APPENDIX D

# Commonwealth of Pennsylvania Specifications and Requirements Package

### **NORMAL HOURS:**

Services, Utilities and Maintenance will be provided daily, 7 days a week, 24 hour access and use of the premises and lease amenities as necessary.

The Commonwealth shall have access to the leased space at all times, including, but not limited to, the use of elevators, toilets, lights and operation of business machines without additional payment.

### **PARKING REQUIRED:**

The minimum number of parking spaces must be included in your proposal . When the Local code requirement for parking to sq. ft. ratio of parking spaces available on site indicates that the Commonwealth is entitled to more spaces than the specified minimum, then those additional spaces shall at the Commonwealth option be added to the above stated minimum.

### **CODE AND/OR REGULATIONS CHANGES OR VIOLATIONS:**

When changes occur in Local, State or Federal codes or regulations and the Lessor is required to take action or equipment services or utilities furnished and activities of other occupants are not free of Safety, Health or Fire hazards the Lessor shall promptly take action to comply with code or regulation requirements at his sole expense.

### **LANDSCAPE MAINTENANCE:**

Landscape maintenance is to be performed during the growing season on a weekly cycle and will consist of the following:

Watering, mowing and policing area to keep it free of debris.

Pruning and fertilization are to be done on an as needed basis. In addition, dead or dying plants are to be replaced.

### **SECURITY:**

The Lessor shall provide security comparable to the types of protection given similar enterprises to prevent illegal entry or loitering in the space leased and to prevent unauthorized entry during off-duty hours.

**MORE OR LESS USABLE AREA:**

The Commonwealth shall receive any useable area within the leased premises in excess of that requested free of any and all costs or charges.

In the event there is less space than that requested the Commonwealth shall pay only for the useable area provided and/or shall have the option to exercise its rights under the lease if it deems, in its sole judgment, that the amount of space being provided is insufficient to meet its needs.

**ADJUSTMENT FOR VACANT SPACE:**

If the Commonwealth fails to occupy any portion of the leased premises or vacates the premises in whole or in part prior to expiration of the firm term of the lease, the rental rate shall be reduced as follows:

The rate shall be reduced by that portion of the costs per square foot of operating expenses not required to maintain the space. Said reduction shall occur after the Commonwealth gives 30 days prior notice to the Lessor, and shall continue in effect until the Commonwealth occupies the premises or the lease expires or is terminated.

Exercise of this right by the Commonwealth shall not preclude it from any other options or rights it may have under the lease.

# **APPENDIX E**

## **GEOGRAPHIC BOUNDARIES**

Two (2) mile radius of Routes 422 and 29, Collegeville, Montgomery County